

# Doccia Group®

**La colección mineral**  
Tarifa y Catálogo técnico





# Índice

## 4 **Doccia Group**

### **DOCCIA ST**

- 12 **Platos de ducha ST**
- 13 Sillar ST Standard

### **DOCCIA CLASSIC**

#### **Platos de ducha**

- 14 Caliza
- 16 Canto
- 18 Canto Lateral
- 20 Piedra
- 22 Basalto
- 24 Ardesia
- 26 Pizarra
- 28 Pizarra Semicircular
- 30 Liso Seda
- 32 Liso
- 34 Liso enmarcado
- 36 Liso enmarcado frontal

### **DOCCIA NANOCOATING**

#### **Platos de ducha nanocoating**

- 38 Vesubio
- 40 Amiata
- 42 Stromboli
- 44 Lipari
- 46 Etna

### **PANELES MURALES**

#### **Classic resina**

- 48 Pizarra
- 51 Liso
- 52 Piedra
- 53 Liso Seda

#### **XXL fenólicos**

- 54 Natural

#### **Encimeras ST Standard**

- 56 Holbox ST
- 58 Mucura ST
- 58 Levisa ST
- 58 Roatan ST

#### **Encimeras y lavabos**

- 60 Saona
- 62 Maui
- 64 Balavu / Bondi
- 66 Lavabos
- 67 Guada / Lupe

- 68-81 **Dossier técnico**

Un diseño para cada idea

Canto Lateral



Canto / Stromboli



Ardesia

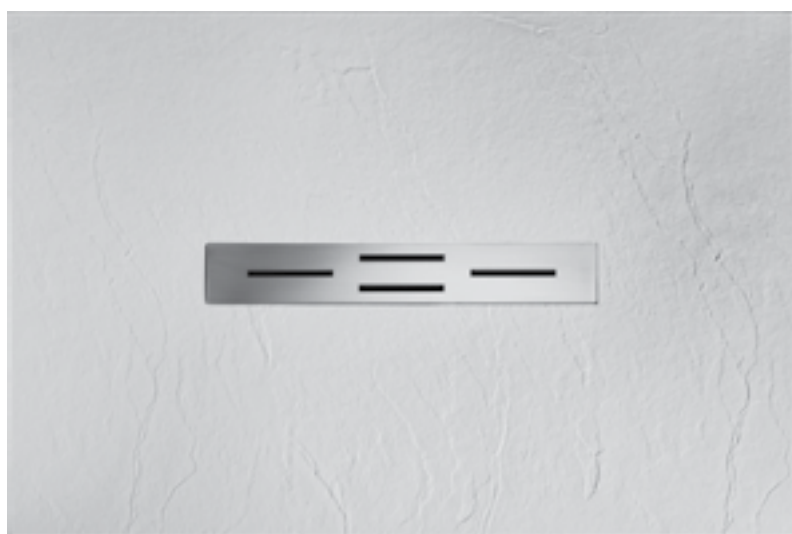

Vesubio

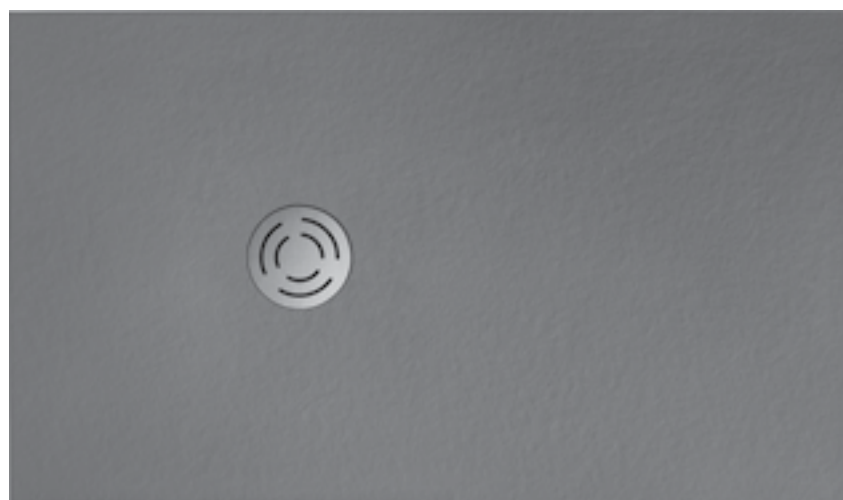

Pizarra Semicircular

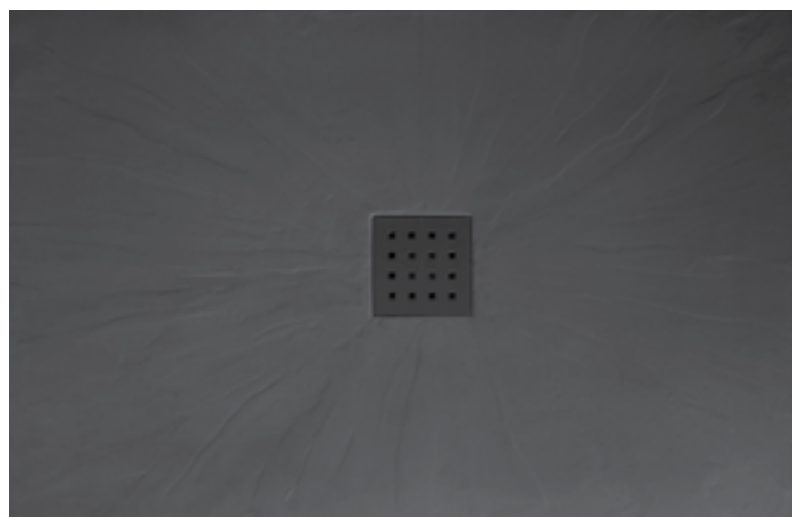
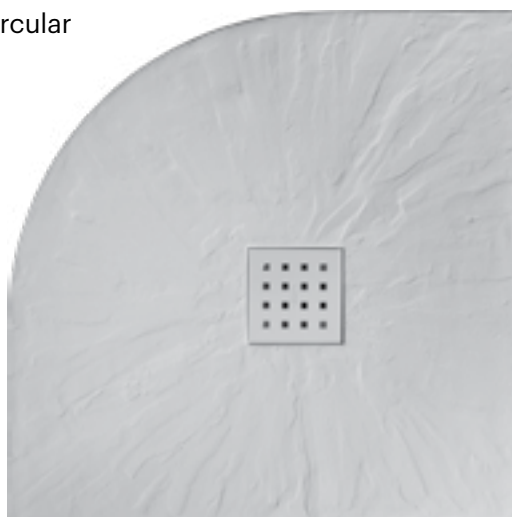

Pizarra

Liso Seda



Caliza

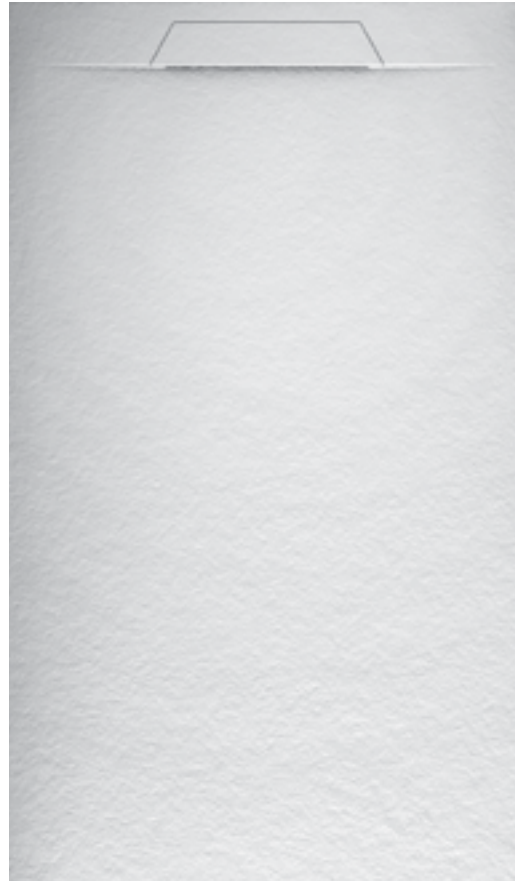

Piedra / Amiata



Liso  
enmarcado

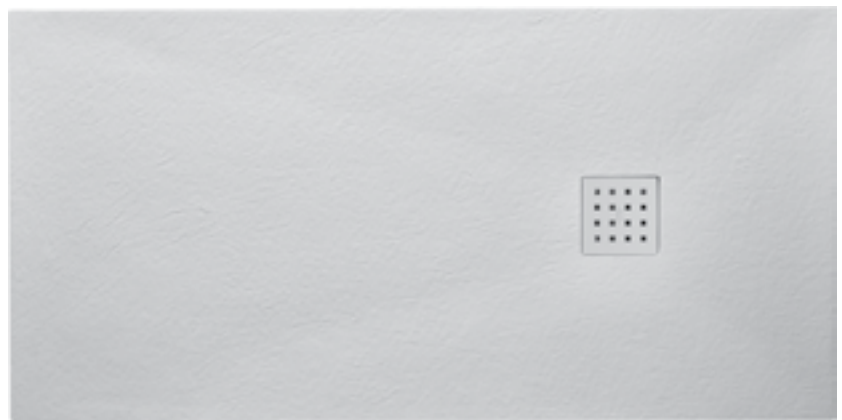

Basalto / Lipari / Sillar

Liso / Etna



Liso Enmarcado frontal

Un diseño para cada idea



Paneles murales

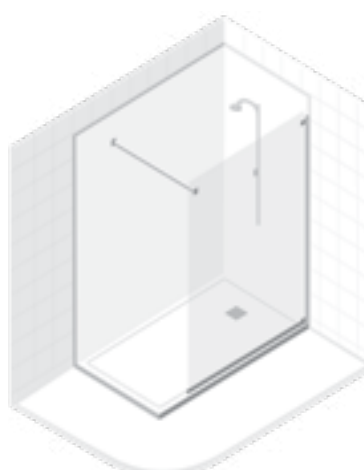
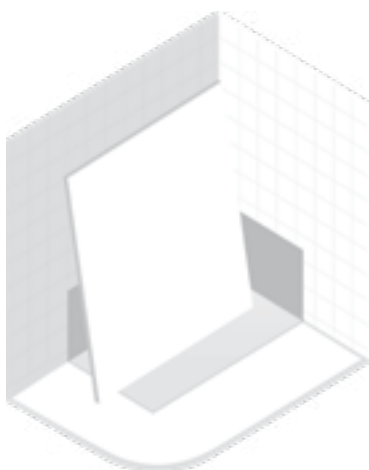

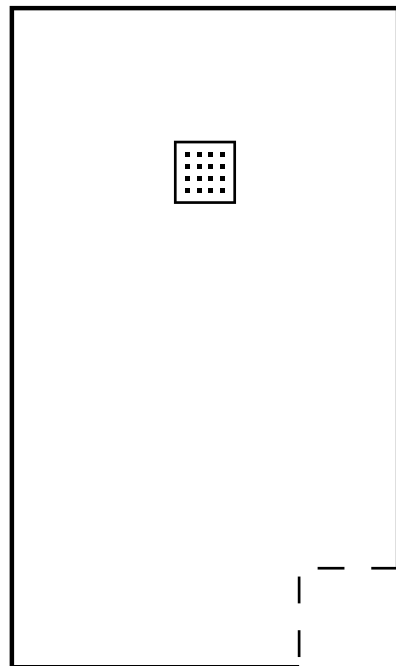
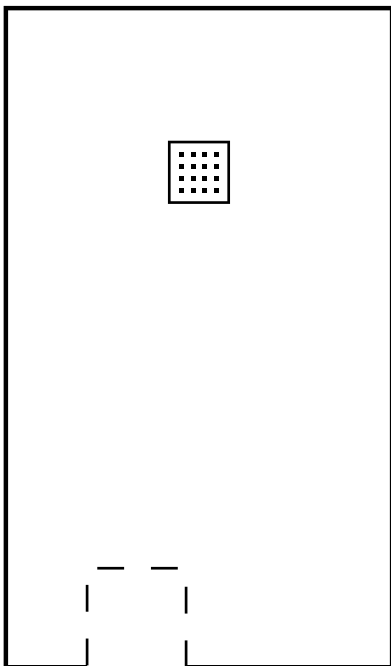
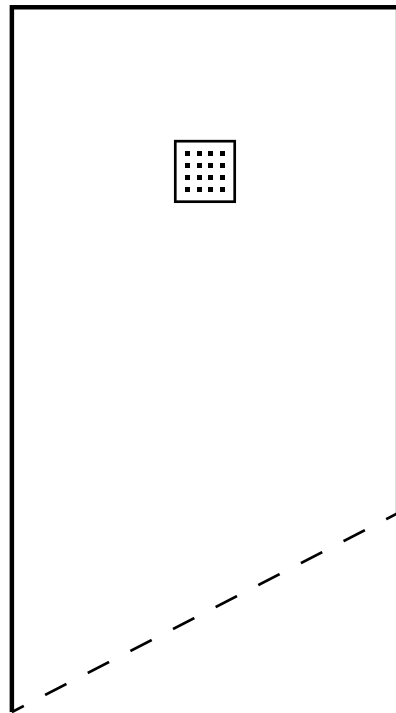
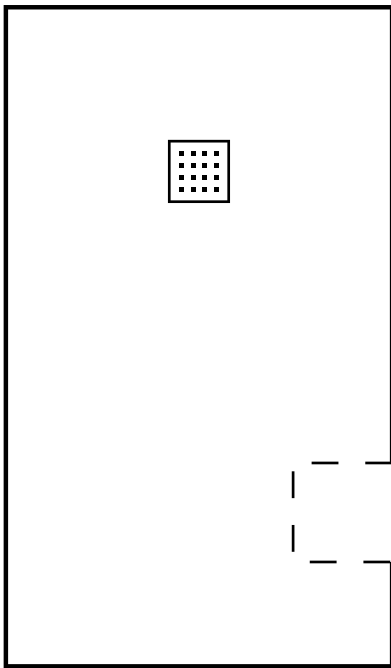
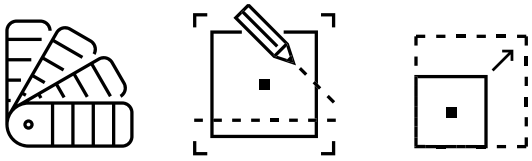

Válvulas

Válvula salida horizontal



Válvula salida vertical



Válvula L drain del plato CALIZA



## Un diseño para cada idea

Personalización: cortes y formas

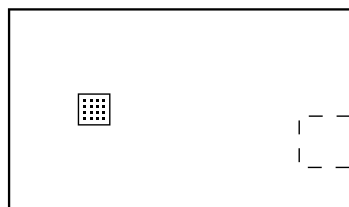
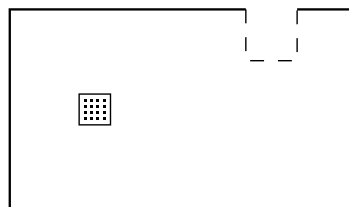
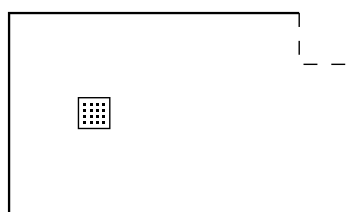
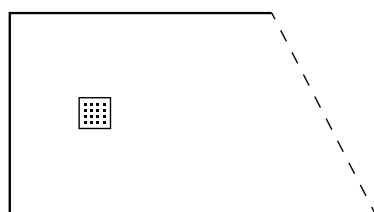
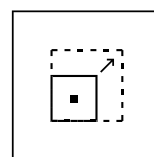
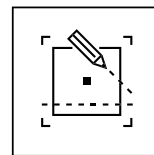
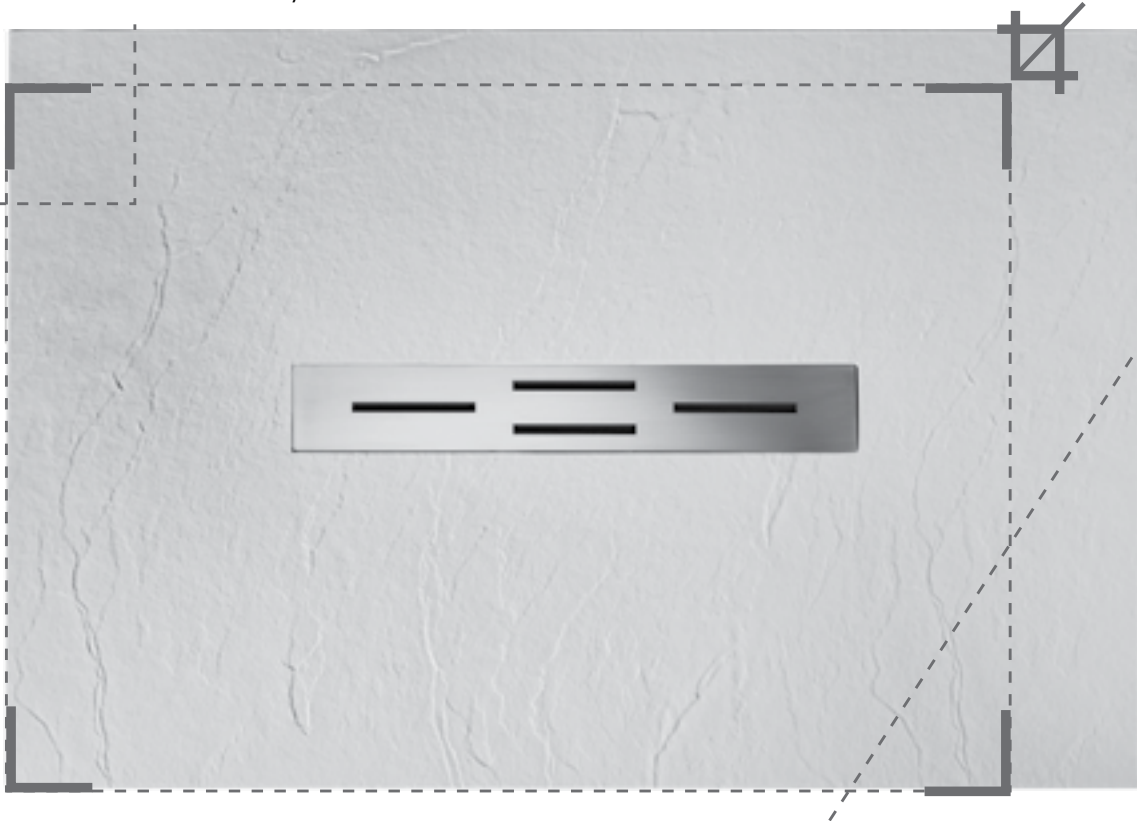

Los platos de ducha Doccia son recortables cm por cm. Se cortan con Disco diamante segmento continuo (especial cerámica)

Los cortes importantes pueden afectar la pendiente del plato, dejando un grosor irregular

El primer corte es gratuito, los siguientes, como los de formas y pilares son opcionales.

Los cortes inferiores a 4 cm se realizaran del mismo lado. Cuando sean superiores a 4 cm, podrán ser repartidas de manera a dejar la válvula centrada.

Es recomendable limitar los cortes al marco plano periférico de 5 a 10 cm. Los cortes superiores son posibles dependiendo de la instalación final del plato de ducha.

A petición del cliente, se pueden repintar los cantos brutos cortados cuando la parte cortada del plato queda visible.



## Un diseño para cada idea

### Rejillas de evacuación

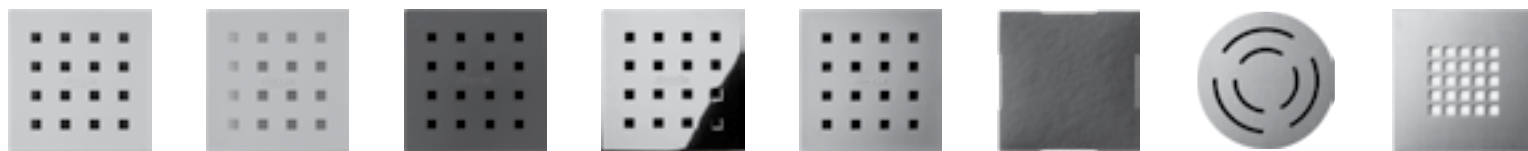

Blanco

Pérgamo

Grafito

Cromo  
Brillo

Cromo  
Mate

Tapa resina  
Piedra

Circular

Inox



Rejilla Inox 316



Tapa resina Canto



Tapa resina Caliza



Rejilla Inox Canto Lateral

### Colores standard

Estos colores son orientativos

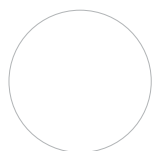

Blanco  
RAL9003

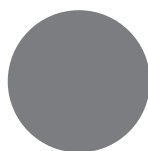

Musgo  
RAL7030



Pérgamo  
RAL1013



Cemento  
RAL7040



Arena  
RAL1019

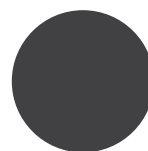

Grafito  
RAL7016

## Los colores de la carta RAL

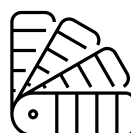

Todos los platos de ducha DOCCIA pueden ser fabricados en una gran elección de colores. El Gel-Coat está disponible en muchos colores de la carta RAL. La masa del plato siempre será del mismo color que el revestimiento.

## Gel coat

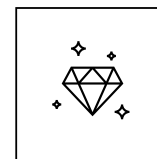

LA DUREZA DE UN DIAMANTE  
REVESTIMIENTO  
GEL-COAT ISO NPG  
SÓLIDO Y DURADERO

El revestimiento es la parte fundamental del plato de ducha porque constituye la mejor protección contra factores como: el envejecimiento, la dureza del agua, la temperatura, la luz, los agentes químicos, golpes. Con sus 600 micras de grosor, nuestro revestimiento de Gel-Coat esta perfectamente fusionado con la masa haciendo del plato de ducha una pieza única, y aportandole una resistencia aumentada.

Es también el que le da su aspecto estructurado y su calidad estética. Su tacto es cálido y agradable, y perfectamente antideslizante. El revestimiento cubre una masa de 80% de materiales minerales con una fuerte densidad para asegurar la planimetría, permitiendo cualquier tipo de instalación. Nuestros platos tienen unas propiedades de resistencia que van más allá de los estándares de calidad encontrados en el mercado permitiendo un uso en las condiciones las mas duras.

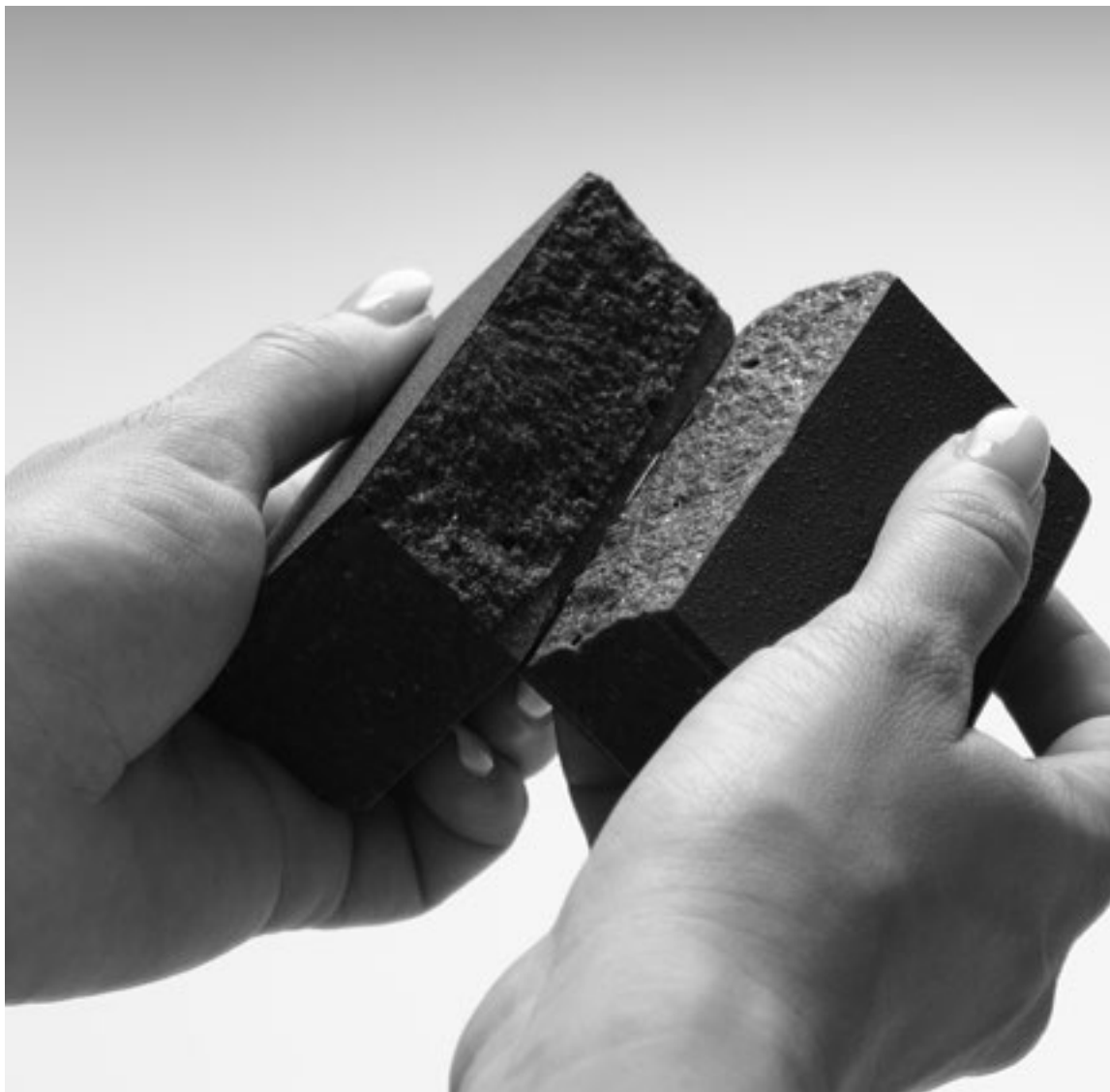

## Un producto hecho para durar

### Propiedades de los platos de ducha

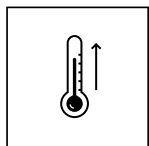

Resistencia a las altas temperaturas

Estabilidad y rigidez

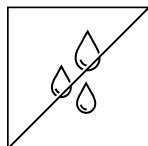

Hidrófugo (Absorción < 0,01%)

No poroso  
Resistencia a la hidrólisis



Antideslizante clase 3 (UNE ENV 12633)

C4 DIN 51907  
PN24 (XPP05-010)

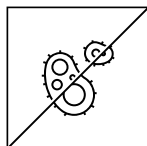

Antibacteriano  
Imputrescible

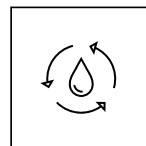

Bajo consumo en agua

fabricado con 80% de materiales naturales

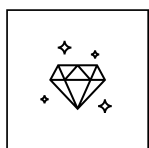

Alta resistencia a los arañazos

Resistencia aumentada a la abrasión

Excelente resistencia al impacto

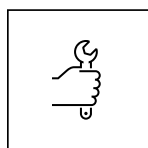

Fácil de montar.

Fácil de reparar

Fácil de cortar



Aptitud a la limpieza (EN 14527)

Resistencia a las manchas (EN 14527)

Gran resistencia a agentes químicos



Toque agradable y mineral

Superficie conserva el calor

Material insonorizado

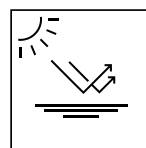

Compacto y homogéneo

Resistencia a los rayos UVA

# PRODUCTO EN STOCK

## PLATO SILLAR ST

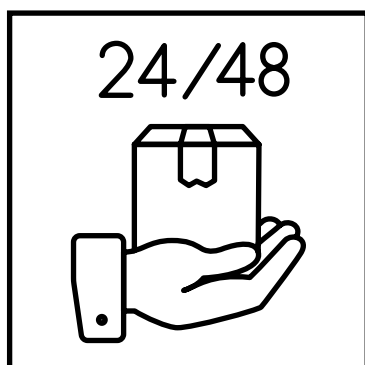

**Disponible  
de 24 a 48 horas**

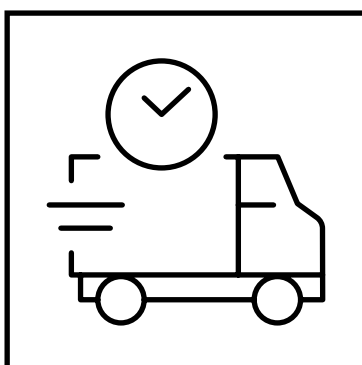

**Servicio  
inmediato**

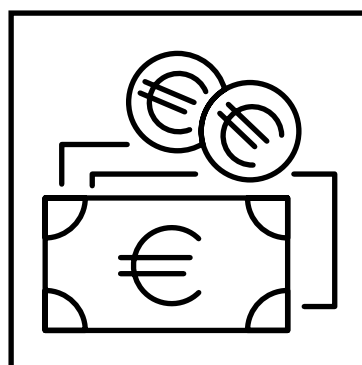

**Precios  
económicos**

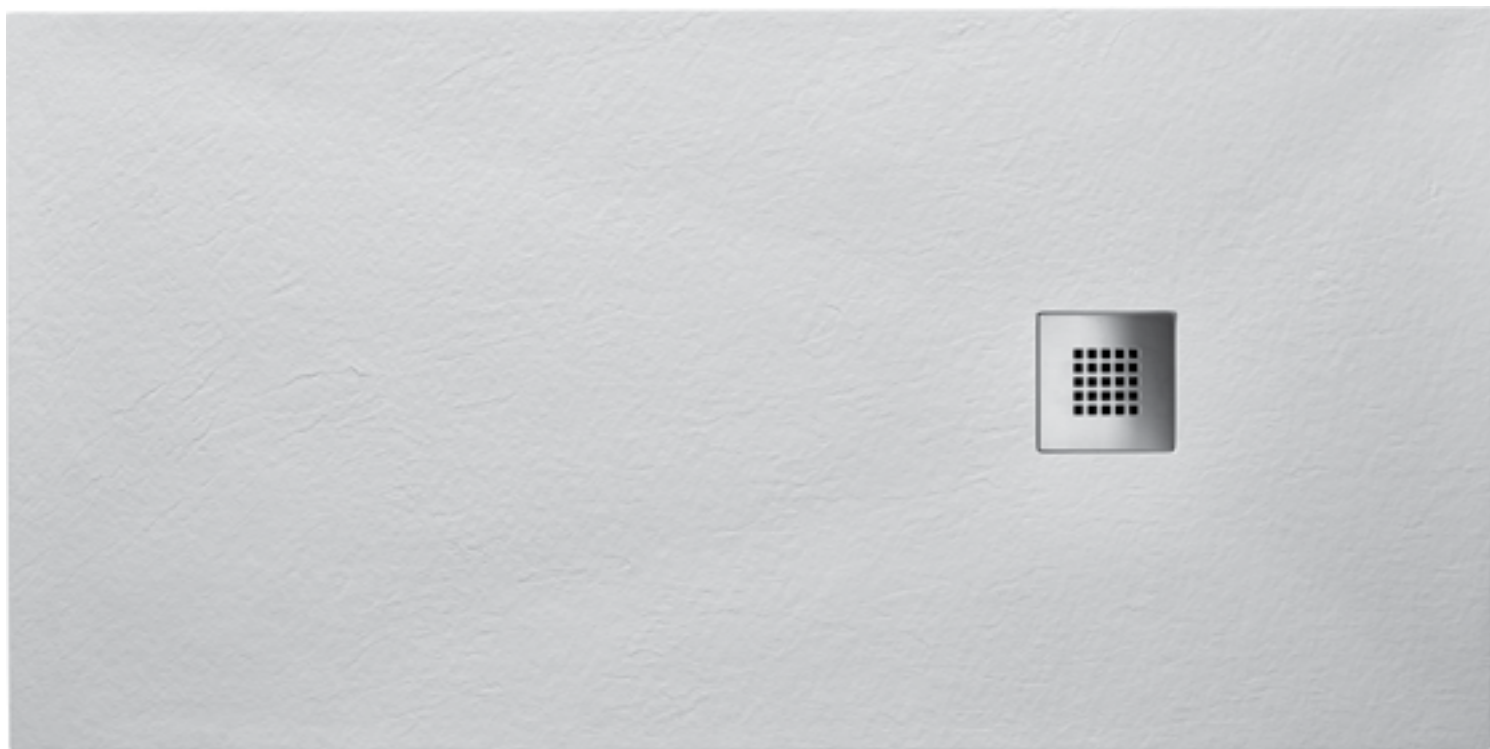

# PRODUCTO EN STOCK



Textura basalto

## SILLAR ST



Rejilla de desagüe:

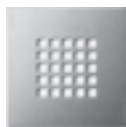

Inox

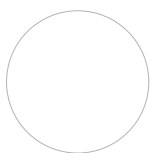
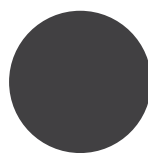
Blanco  
RAL9003Pérgamo  
RAL1013Grafito  
RAL7016

Válvula sifónica en polipropileno 90 mm Ø

Desagüe horizontal.  
40 L/mn.

G9927010101	G9927010102	G9927010103	<b>70 X 100</b>	<b>246 €</b>
G9927012101	G9927012102	G9927012103	<b>70 x 120</b>	<b>258 €</b>
G9927014101	G9927014102	G9927014103	<b>70 x 140</b>	<b>298 €</b>
G9927016101	G9927016102	G9927016103	<b>70 x 160</b>	<b>318 €</b>
G9927018101	G9927018102	G9927018103	<b>70 x 180</b>	<b>334 €</b>
G9927510101	G9927510102	G9927510103	<b>75 X 100</b>	<b>258 €</b>
G9927512101	G9927512102	G9927512103	<b>75 x 120</b>	<b>278 €</b>
G9927514101	G9927514102	G9927514103	<b>75 x 140</b>	<b>314 €</b>
G9927516101	G9927516102	G9927516103	<b>75 x 160</b>	<b>336 €</b>
G9927518101	G9927518102	G9927518103	<b>75 x 180</b>	<b>352 €</b>
G9928010101	G9928010102	G9928010103	<b>80 X 100</b>	<b>258 €</b>
G9928012101	G9928012102	G9928012103	<b>80 x 120</b>	<b>278 €</b>
G9928014101	G9928014102	G9928014103	<b>80 x 140</b>	<b>314 €</b>
G9928016101	G9928016102	G9928016103	<b>80 x 160</b>	<b>336 €</b>
G9928018101	G9928018102	G9928018103	<b>80 x 180</b>	<b>352 €</b>
G9929010101	G9929010102	G9929010103	<b>90 x 100</b>	<b>296 €</b>
G9929012101	G9929012102	G9929012103	<b>90 x 120</b>	<b>322 €</b>
G9929014101	G9929014102	G9929014103	<b>90 x 140</b>	<b>358 €</b>
G9929016101	G9929016102	G9929016103	<b>90 x 160</b>	<b>382 €</b>
G9929018101	G9929018102	G9929018103	<b>90 x 180</b>	<b>402 €</b>

## CALIZA Textura piedra

Standard

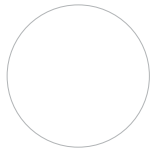

Blanco  
RAL9003



Pérgamo  
RAL1013

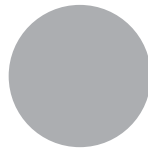

Arena  
RAL1019

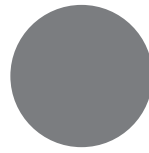

Musgo  
RAL7030

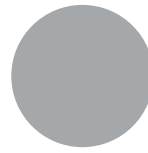

Cemento  
RAL7040

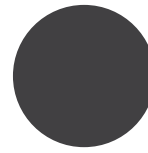

Grafito  
RAL7016

E (cm)	D (cm)	A	B	H	kg	V (m3)
80	120	6,8	40	3	50	0,22
	140	6,8	40	3	59	0,26
	160	6,8	40	3	67	0,29
	180	6,8	40	3	75	0,33
	200	6,8	40	3	84	0,36
90	120	6,8	45	3	47	0,25
	140	6,8	45	3	66	0,29
	160	6,8	45	3	75	0,33
	180	6,8	45	3	85	0,37
	200	6,8	45	3	94	0,40
100	120	6,8	50	3	63	0,27
	140	6,8	50	3	73	0,32
	160	6,8	50	3	84	0,36
	180	6,8	50	3	94	0,40
	200	6,8	50	3	110	0,47

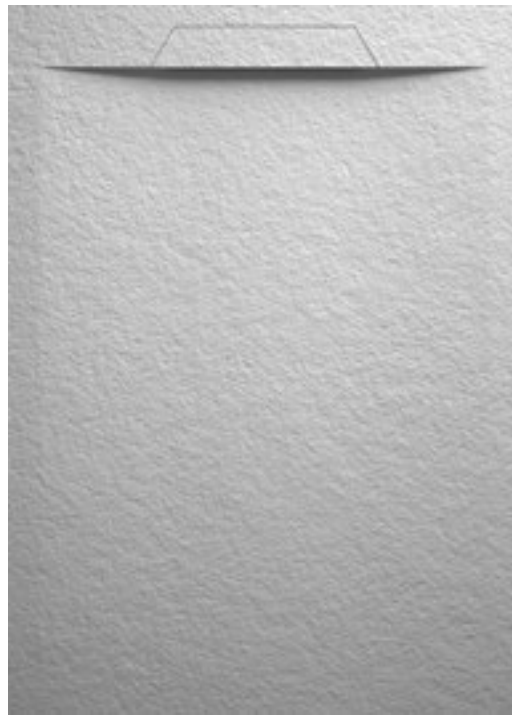

D: 120 - 200

E: 80-90-100

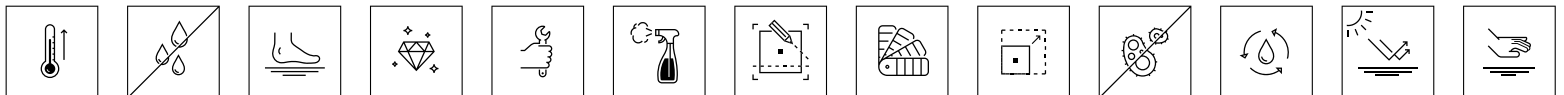

Rejilla de desagüe:

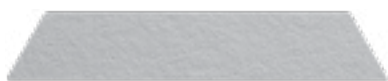

Tapa Resina Caliza

Válvula de drenaje lineal



Desague Horizontal.

Tarifas			
D—E cm.	80	90	100
120	<b>388 €</b>	<b>458 €</b>	<b>668 €</b>
140	<b>442 €</b>	<b>526 €</b>	<b>736 €</b>
160	<b>482 €</b>	<b>586 €</b>	<b>804 €</b>
180	<b>522 €</b>	<b>664 €</b>	<b>872 €</b>
200	<b>642 €</b>	<b>734 €</b>	<b>942 €</b>

Incrementos	
RAL	<b>70 €</b>
Corte solo en largo (maxi. 10 cm)	<b>Incluido</b>

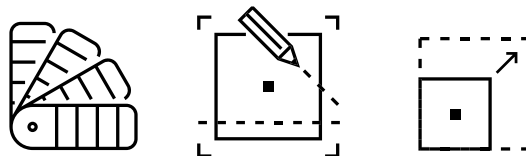
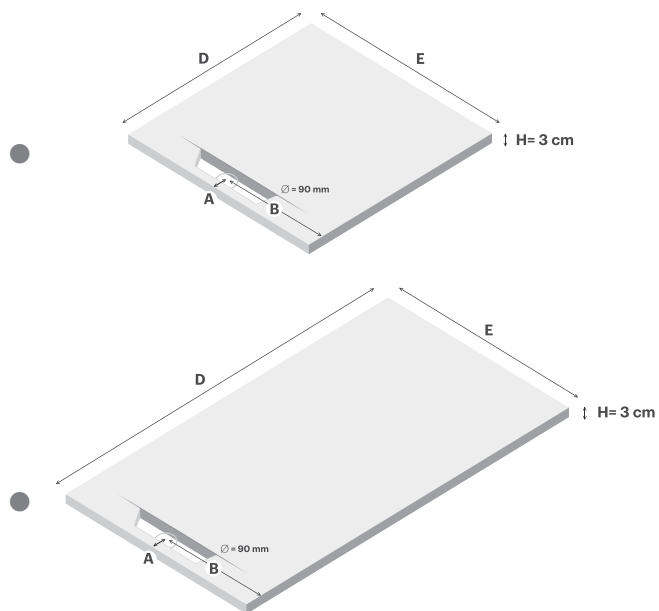

CM	80	90	100
120	●	●	●
140	●	●	●
160	●	●	●
180	●	●	●
200	●	●	●

## CANTO Textura piedra

Standard

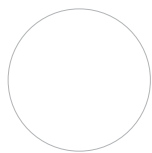

Blanco  
RAL9003



Pérgamo  
RAL1013

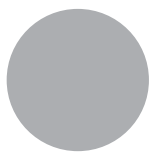

Arena  
RAL1019

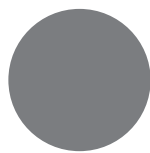

Musgo  
RAL7030

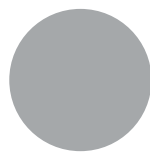

Cemento  
RAL7040

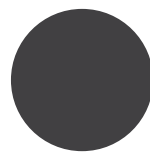

Grafito  
RAL7016

E (cm)	D (cm)	A	B	H	kg	V (m3)
80	100	15	40	3,8	52	0,21
	120	15	40	3,8	63	0,22
	140	15	40	3,8	73	0,26
	160	15	40	3,8	84	0,29
	180	15	40	3,8	94	0,33
200	15	40	3,8	104	0,36	

90	100	15	45	3,8	59	0,21
	120	15	45	3,8	71	0,25
	140	15	45	3,8	82	0,29
	160	15	45	3,8	94	0,33
	180	15	45	3,8	106	0,37
200	15	45	3,8	117	0,40	

100	120	15	50	3,8	78	0,27
	140	15	50	3,8	91	0,32
	160	15	50	3,8	104	0,36
	180	15	50	3,8	117	0,40
	200	15	50	3,8	130	0,44



E: 80-90-100

D: 100 - 200

Opcional:



Tapa resina Canto

Válvula sifónica en polipropileno 90 mm Ø



Desagüe vertical.  
40 L/mn.

VÁLVULAS EN OPCION



PVP: 32€  
desagüe  
horizontal

PVP: 32€  
desagüe  
vertical

Válvula VIEGA 36 L/mn

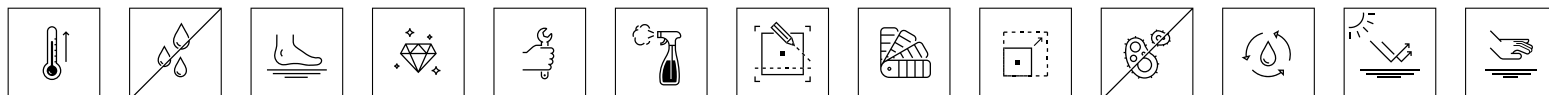



Rejilla de desagüe:



Acero inox 316

Válvula sifónica en polipropileno 90 mm Ø



Desagüe horizontal.  
40 L/mn.

Tarifas			
D—E cm.	80	90	100
100	<b>352 €</b>	<b>388 €</b>	
120	<b>388 €</b>	<b>458 €</b>	<b>668 €</b>
140	<b>442 €</b>	<b>526 €</b>	<b>736 €</b>
160	<b>482 €</b>	<b>586 €</b>	<b>804 €</b>
180	<b>522 €</b>	<b>664 €</b>	<b>872 €</b>
200	<b>642 €</b>	<b>734 €</b>	<b>942 €</b>

Incrementos	
RAL	<b>70 €</b>
Corte solo en largo (maxi. 10 cm)	<b>Incluido</b>

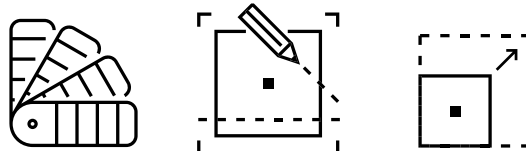
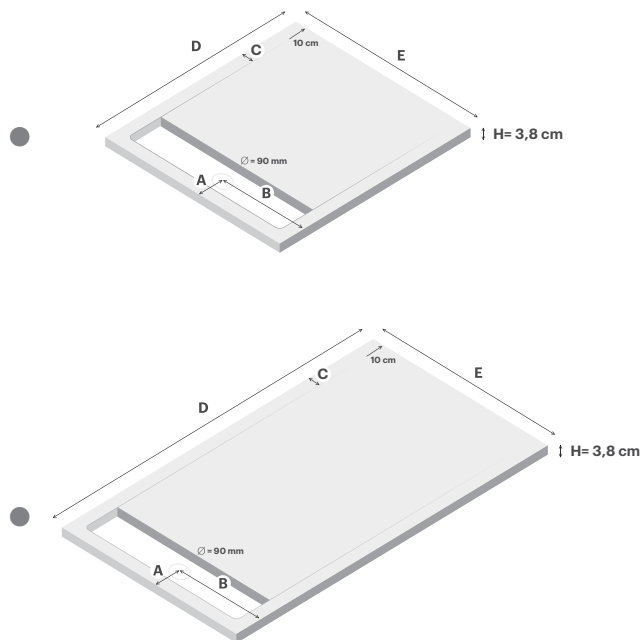

CM	80	90	100
120	●	●	●
140	●	●	●
160	●	●	●
180	●	●	●
200	●	●	●

## CANTO LATERAL Textura piedra

Standard

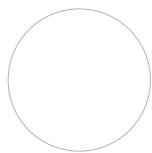

Blanco  
RAL9003



Pérgamo  
RAL1013

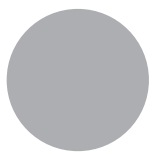

Arena  
RAL1019

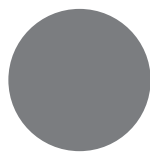

Musgo  
RAL7030

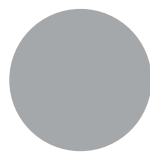

Cemento  
RAL7040

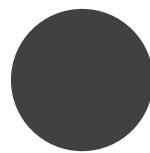

Grafito  
RAL7016

E (cm)	D (cm)	A	B	H	kg	V (m3)
80	120	10,5	60	3,8	63	0,22
	140	10,5	70	3,8	73	0,26
	160	10,5	80	3,8	84	0,29
	180	10,5	90	3,8	94	0,33
	200	10,5	100	3,8	104	0,36

90	120	10,5	60	3,8	71	0,25
	140	10,5	70	3,8	82	0,29
	160	10,5	80	3,8	94	0,33
	180	10,5	90	3,8	106	0,37
	200	10,5	100	3,8	117	0,40

100	120	10,5	60	3,8	78	0,27
	140	10,5	70	3,8	91	0,32
	160	10,5	80	3,8	104	0,36
	180	10,5	90	3,8	117	0,40
	200	10,5	100	3,8	130	0,44



D: 120 - 200

E: 80-90-100

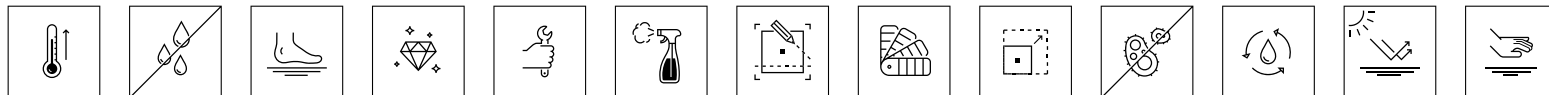

Rejilla de desagüe:



Acero inox 316

Válvula sifónica en polipropileno 90 mm Ø



Desagüe horizontal.  
40 L/mn.

Tarifas			
D—E cm.	80	90	100
120	<b>388 €</b>	<b>458 €</b>	<b>668 €</b>
140	<b>442 €</b>	<b>526 €</b>	<b>736 €</b>
160	<b>482 €</b>	<b>586 €</b>	<b>804 €</b>
180	<b>522 €</b>	<b>664 €</b>	<b>872 €</b>
200	<b>642 €</b>	<b>734 €</b>	<b>942 €</b>

Aumentos	
RAL	<b>70 €</b>
Corte solo en ancho (maxi. 10 cm)	<b>Incluido</b>

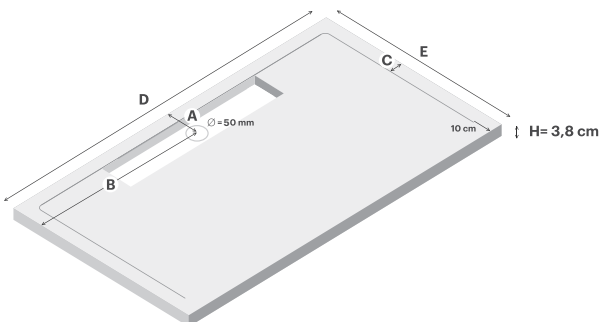
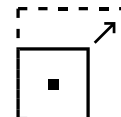
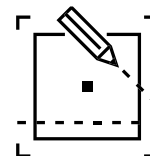
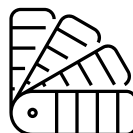
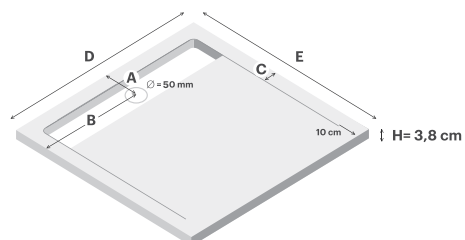

CM	80	90	100
120	●	●	●
140	●	●	●
160	●	●	●
180	●	●	●
200	●	●	●

## PIEDRA Textura piedra

Standard

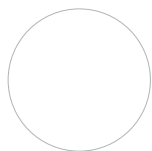

Blanco  
RAL9003



Pérgamo  
RAL1013

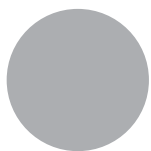

Arena  
RAL1019

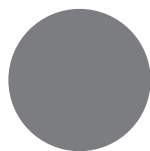

Musgo  
RAL7030

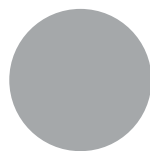

Cemento  
RAL7040

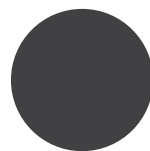

Grafito  
RAL7016

E (cm)	D (cm)	A	B	H	kg	V (m3)
70	90	45	35	3,5	36	0,15
	100	50	35	3,5	40	0,17
	120	± 43	35	3,5	48	0,20
	140	± 43	35	3,5	56	0,23
	160	± 43	35	3,5	64	0,26
180	± 43	35	3,5	72	0,29	

80	80	40	40	3,5	37	0,15
	100	50	40	3,5	46	0,19
	120	± 43	40	3,5	55	0,22
	140	± 43	40	3,5	64	0,26
	160	± 43	40	3,5	73	0,29
	180	± 43	40	3,5	83	0,33
200	± 43	40	3,5	84	0,36	

90	90	45	45	3,5	47	0,19
	120	± 43	45	3,5	62	0,25
	140	± 43	45	3,5	72	0,29
	160	± 43	45	3,5	83	0,33
	180	± 43	45	3,5	93	0,37

100	120	± 43	50	3,5	69	0,27
	140	± 43	50	3,5	80	0,32
	160	± 43	50	3,5	92	0,36
	180	± 43	50	3,5	103	0,40
	200	± 43	50	3,5	114	0,47

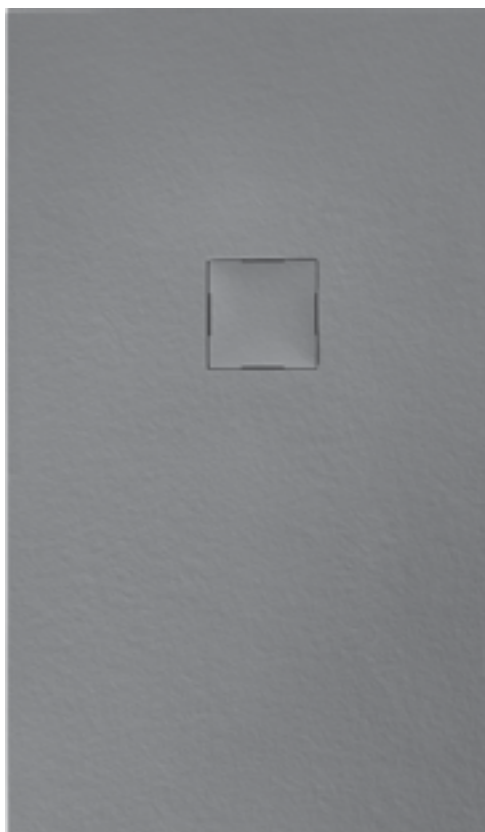

E: 70-80-90-100

D: 80 - 200

Opcional:



Cromo Brillo

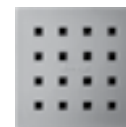

Cromo Mate

Válvula sifónica en polipropileno 90 mm Ø



Desagüe vertical.  
40 L/mn.

VÁLVULAS EN OPCION



PVP: 32€  
desagüe horizontal



PVP: 32€  
desagüe vertical

Válvula VIEGA 36 L/mn

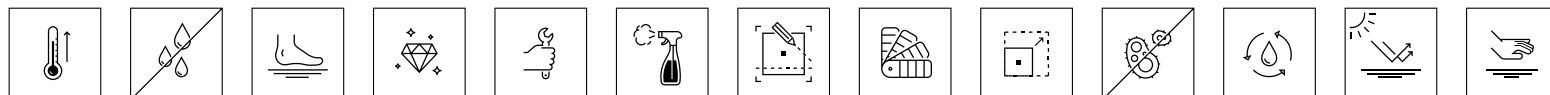

Rejilla de desagüe:



Tapa color del plato  
Rejilla de resina  
Evacuación reducida

Válvula sifónica en  
polipropileno 90 mm Ø



Desagüe horizontal.  
40 L/mn.

## Tarifas

D—E cm.	70	80	90	100
80		<b>306 €</b>		
90	<b>274 €</b>		<b>312 €</b>	
100	<b>286 €</b>	<b>312 €</b>		
120	<b>316 €</b>	<b>338 €</b>	<b>398 €</b>	<b>539 €</b>
140	<b>360 €</b>	<b>384 €</b>	<b>458 €</b>	<b>640 €</b>
160	<b>388 €</b>	<b>420 €</b>	<b>510 €</b>	<b>699 €</b>
180	<b>418 €</b>	<b>454 €</b>	<b>578 €</b>	<b>759 €</b>
200		<b>558 €</b>		<b>895 €</b>

## Aumentos

RAL	<b>70 €</b>
Primer corte	<b>Incluido</b>
Resto de cortes	<b>40 €</b>

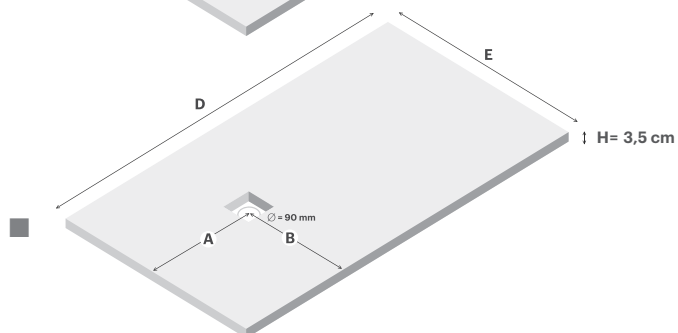
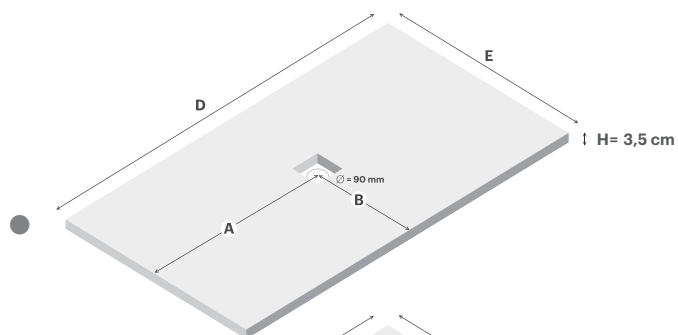

CM	70	80	90	100
80		●		
90	●		●	
100	●	●		
120	■	■	■	■
140	■	■	■	■
160	■	■	■	■
180	■	■	■	■
200		■		■

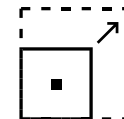
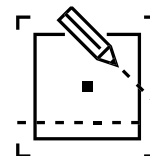
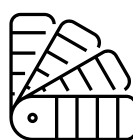

EN STOCK

24H\*

48H\*

\* salida de fábrica

\* Para pedidos unitarios en el limite del estock disponible

70 x 90

70 x 100

80 x 100

90 x 120

70 x 120

80 x 120

70 x 140

80 x 140

70 x 160

80 x 160

70 x 180

80 x 180

Rejilla Resina color del plato, Válvula Salida horizontal  
Color Blanco, Grafito, Pergamo

## BASALTO Textura basalto

Standard

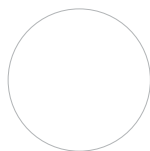

Blanco  
RAL9003



Pérgamo  
RAL1013



Arena  
RAL1019

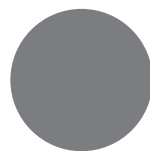

Musgo  
RAL7030

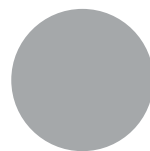

Cemento  
RAL7040

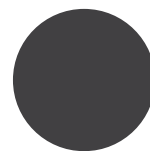

Grafito  
RAL7016

E (cm)	D (cm)	A	B	H	kg	V (m3)
70	100	50	35	3	37	0,17
	120	± 43	35	3	44	0,20
	140	± 43	35	3	51	0,23
	160	± 43	35	3	59	0,26
	180	± 43	35	3	66	0,29
75	100	50	37,5	3	37	0,17
	120	± 43	37,5	3	44	0,20
	140	± 43	37,5	3	51	0,23
	160	± 43	37,5	3	59	0,26
	180	± 43	37,5	3	66	0,29
80	100	50	40	3	42	0,19
	120	± 43	40	3	50	0,22
	140	± 43	40	3	59	0,26
	160	± 43	40	3	67	0,29
	180	± 43	40	3	75	0,33
90	90	45	45	3	43	0,19
	100	50	45	3	47	0,25
	120	± 43	45	3	57	0,25
	140	± 43	45	3	66	0,29
	160	± 43	45	3	75	0,33
100	100	50	50	3	52	0,23
	120	± 43	50	3	63	0,27
	140	± 43	50	3	73	0,32
	160	± 43	50	3	84	0,36
	180	± 43	50	3	94	0,40
200	± 43	50	3	104	0,47	

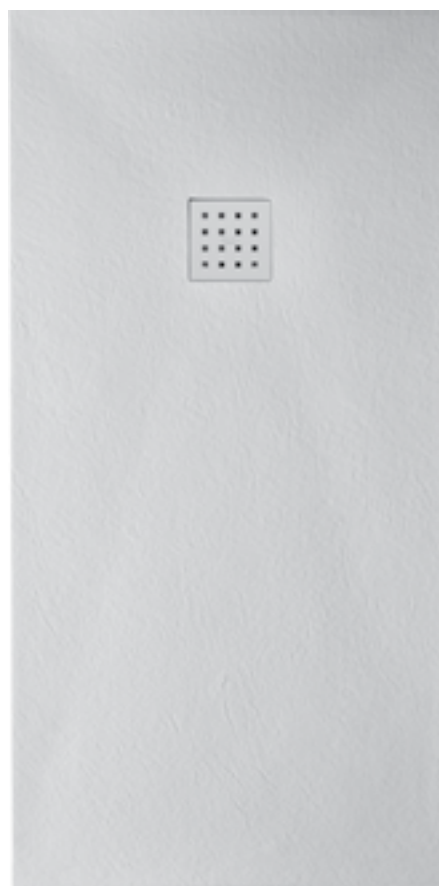

E: 70-75-80-90-100

D: 90 - 200

Opcional:



Cromo Brillo

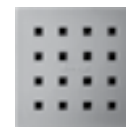

Cromo Mate

Válvula sifónica en polipropileno 90 mm Ø



Desagüe vertical.  
40 L/mn.

VÁLVULAS EN OPCION



PVP: 32€  
desagüe horizontal



PVP: 32€  
desagüe vertical

Válvula VIEGA 30 L/mn

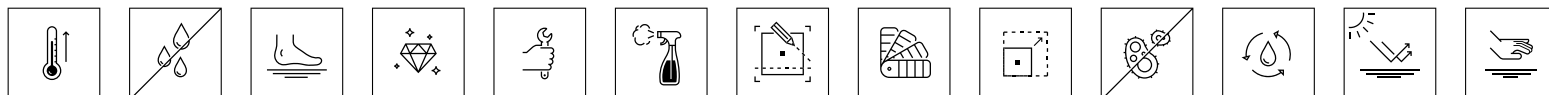

Rejilla de desagüe:

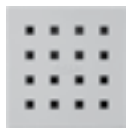

Blanco

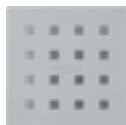

Pérgamo

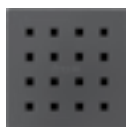

Grafito

Válvula sifónica en polipropileno 90 mm Ø



Desagüe horizontal.  
40 L/mn.

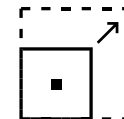
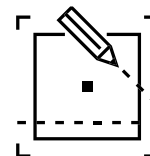
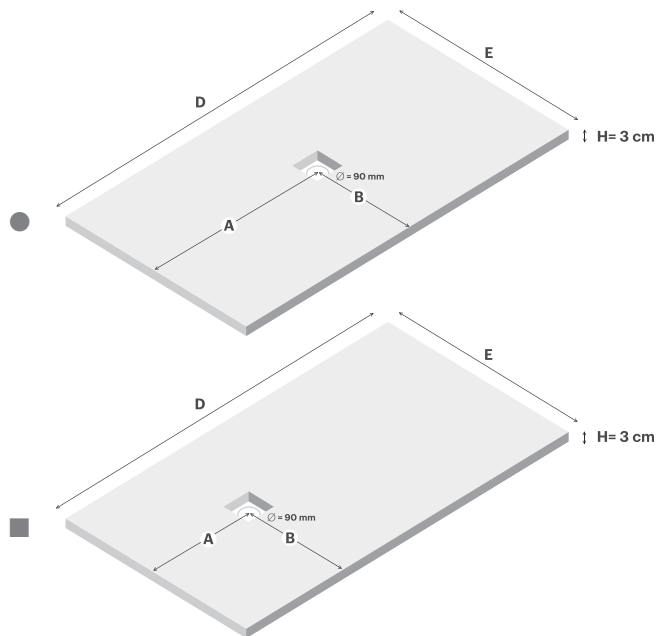

Tarifas

D—E cm.	70	75	80	90	100
90				<b>312 €</b>	
100	<b>286 €</b>	<b>312 €</b>	<b>312 €</b>	<b>338 €</b>	<b>474 €</b>
120	<b>316 €</b>	<b>338 €</b>	<b>338 €</b>	<b>398 €</b>	<b>539 €</b>
140	<b>360 €</b>	<b>384 €</b>	<b>384 €</b>	<b>458 €</b>	<b>640 €</b>
160	<b>388 €</b>	<b>420 €</b>	<b>420 €</b>	<b>510 €</b>	<b>699 €</b>
180	<b>418 €</b>	<b>454 €</b>	<b>454 €</b>	<b>578 €</b>	<b>759 €</b>
200					<b>895 €</b>

Incrementos

RAL	<b>70 €</b>
Primer corte	<b>Incluido</b>
Resto de cortes	<b>40 €</b>

CM	70	75	80	90	100
90				●	
100	●	●	●	●	●
120	■	■	■	■	■
140	■	■	■	■	■
160	■	■	■	■	■
180	■	■	■	■	■
200					■

## ARDESIA Textura pizarra

Standard

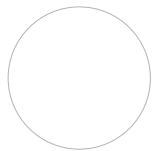

Blanco  
RAL9003



Pérgamo  
RAL1013

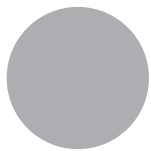

Arena  
RAL1019

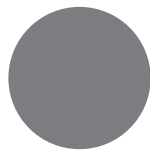

Musgo  
RAL7030

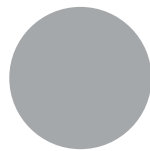

Cemento  
RAL7040

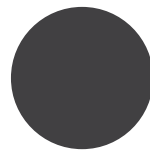

Grafito  
RAL7016

E (cm)	D (cm)	A	B	H	kg	V (m3)
70	100	50	35	3	40	0,17
	120	60	35	3	48	0,20
	140	70	35	3	56	0,23
	160	80	35	3	64	0,26
	180	90	35	3	72	0,29
	200	100	35	3	80	0,32
80	100	50	40	3	46	0,19
	120	60	40	3	55	0,22
	140	70	40	3	64	0,26
	160	80	40	3	73	0,29
	180	90	40	3	83	0,33
	200	100	40	3	92	0,36
90	100	50	45	3	52	0,21
	120	60	45	3	62	0,25
	140	70	45	3	72	0,29
	160	80	45	3	83	0,33
	180	90	45	3	93	0,37
	200	100	45	3	103	0,40
100	100	50	50	3	57	0,23
	120	60	50	3	69	0,27
	140	70	50	3	80	0,32
	160	80	50	3	92	0,36
	180	90	50	3	103	0,40
	200	100	50	3	114	0,44
110	200	100	55	3	120	0,50



E: 70-80-90-100-110

D: 100 - 200

Opcional:

Válvula sifónica elíptica



Desagüe vertical.  
40 L/mn.

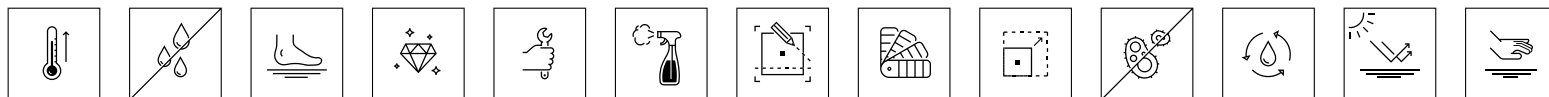



Rejilla de desagüe:



Acero inox 316

Válvula sifónica elíptica



Desagüe horizontal.  
40 L/mn.

Tarifas					
D—E cm.	70	80	90	100	110
100	<b>330 €</b>	<b>352 €</b>	<b>388 €</b>	<b>598 €</b>	
120	<b>364 €</b>	<b>388 €</b>	<b>458 €</b>	<b>668 €</b>	
140	<b>414 €</b>	<b>442 €</b>	<b>526 €</b>	<b>736 €</b>	
160	<b>446 €</b>	<b>482 €</b>	<b>586 €</b>	<b>804 €</b>	
180	<b>480 €</b>	<b>522 €</b>	<b>664 €</b>	<b>872 €</b>	
200	<b>526 €</b>	<b>642 €</b>	<b>734 €</b>	<b>942 €</b>	<b>1060 €</b>

Incrementos	
RAL	<b>70 €</b>
Primer corte	<b>Incluido</b>
Resto de cortes	<b>40 €</b>

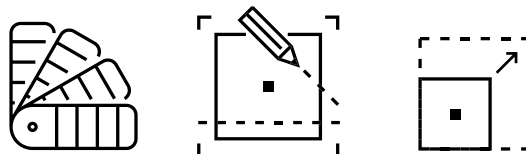
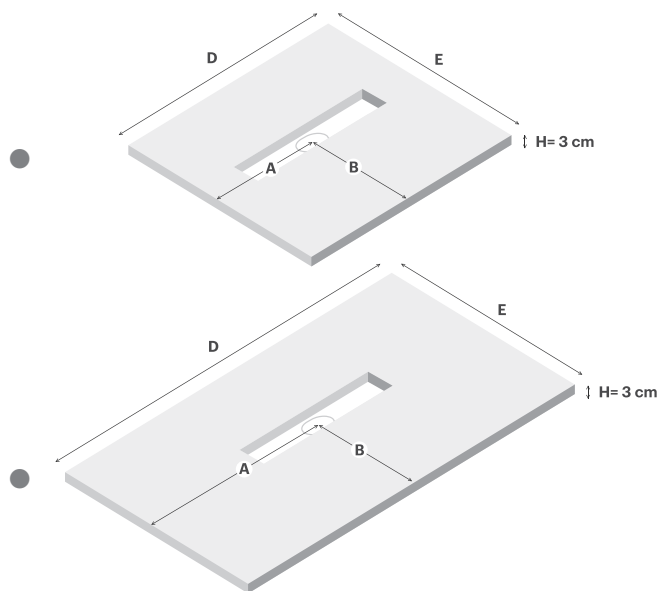

CM	70	80	90	100	110
100	●	●	●	●	
120	●	●	●	●	
140	●	●	●	●	
160	●	●	●	●	
180	●	●	●	●	
200	●	●	●	●	●

## PIZARRA Textura pizarra

Standard

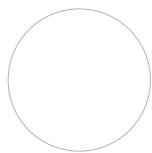

Blanco  
RAL9003



Pérgamo  
RAL1013

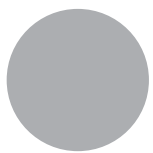

Arena  
RAL1019

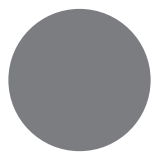

Musgo  
RAL7030

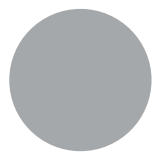

Cemento  
RAL7040

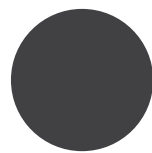

Grafito  
RAL7016

E (cm)	D (cm)	A	B	H	kg	V (m3)
70	90	45	35	3	33	0,15
	100	50	35	3	37	0,17
	120	± 43	35	3	44	0,20
	140	± 43	35	3	51	0,23
	160	± 43	35	3	59	0,26
	180	± 43	35	3	66	0,29
	200	± 43	35	3	70	0,31
80	80	40	40	3	34	0,15
	100	50	40	3	42	0,19
	120	± 43	40	3	50	0,22
	140	± 43	40	3	59	0,26
	160	± 43	40	3	67	0,29
	180	± 43	40	3	75	0,33
	200	± 43	40	3	84	0,36
90	90	45	45	3	43	0,19
	120	± 43	45	3	47	0,25
	140	± 43	45	3	66	0,29
	160	± 43	45	3	75	0,33
	180	± 43	45	3	85	0,37
200	± 43	45	3	94	0,40	
100	120	60	50	3	63	0,27
	140	70	50	3	73	0,32
	160	80	50	3	84	0,36
	180	90	50	3	94	0,40
	210	105	50	3	110	0,47



E: 70-80-90-100

D: 80 - 210

Opcional:



Cromo Brillo

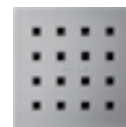

Cromo Mate

Válvula sifónica en polipropileno 90 mm Ø



Desagüe vertical.  
40 L/mn.

VÁLVULAS EN OPCION



PVP: 32€  
desagüe horizontal



PVP: 32€  
desagüe vertical

Válvula VIEGA 36 L/mn

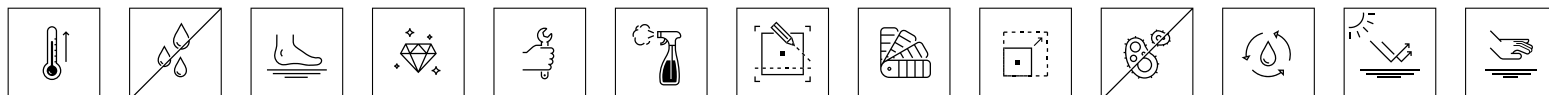

Rejilla de desagüe:

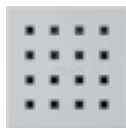

Blanco

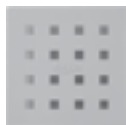

Pérgamo



Grafito

Válvula sifónica en polipropileno 90 mm Ø

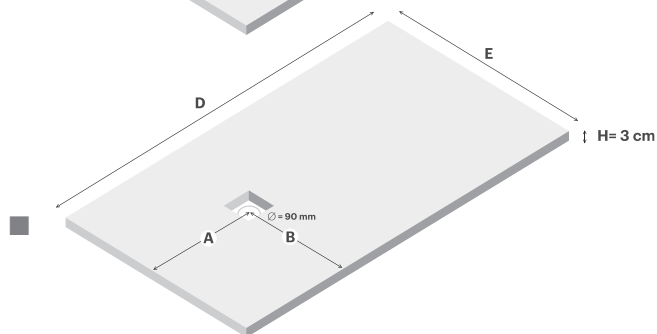
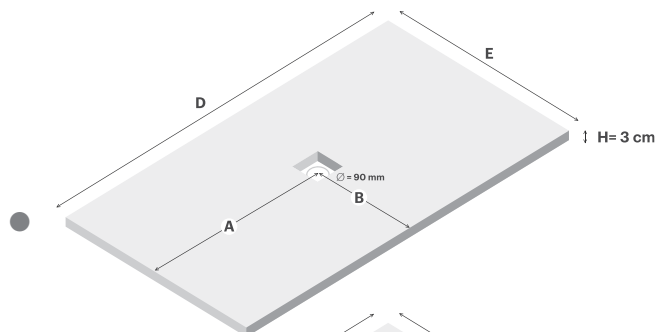
Desagüe horizontal.  
40 L/mn.

CM	70	80	90	100
80		●		
90	●		●	
100	●	●		
120	■	■	■	●
140	■	■	■	●
160	■	■	■	●
180	■	■	■	●
200	■	■	■	
210				●

## Tarifas

D—E cm.	70	80	90	100
80		<b>306 €</b>		
90	<b>274 €</b>		<b>312 €</b>	
100	<b>286 €</b>	<b>312 €</b>		
120	<b>316 €</b>	<b>338 €</b>	<b>398 €</b>	<b>539 €</b>
140	<b>360 €</b>	<b>384 €</b>	<b>458 €</b>	<b>640 €</b>
160	<b>388 €</b>	<b>420 €</b>	<b>510 €</b>	<b>699 €</b>
180	<b>418 €</b>	<b>454 €</b>	<b>578 €</b>	<b>759 €</b>
200	<b>458 €</b>	<b>558 €</b>	<b>646 €</b>	
210				<b>895 €</b>

## Incrementos

RAL	<b>70 €</b>
Primer corte	<b>Incluido</b>
Resto de cortes	<b>40 €</b>

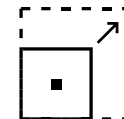
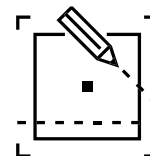
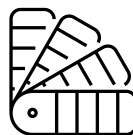

EN STOCK

24H\*

48H\*

\* salida de fábrica

\* Para pedidos unitarios en el limite del estock disponible

70 x 90	80 x 80	90 x 90	100 x 120
70 x 100	80 x 100	90 x 120	100 x 140
70 x 120	80 x 120	90 x 140	100 x 160
70 x 140	80 x 140	90 x 160	100 x 180
70 x 160	80 x 160	90 x 180	100 x 210
70 x 180	80 x 180	90 x 200	
	80 x 200		

Rejilla del color del plato, Válvula Salida horizontal  
Color Blanco, Grafito, Pérgamo

## PIZARRA SEMICIRCULAR Textura pizarra

Standard

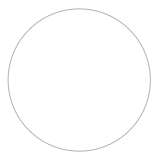

Blanco  
RAL9003



Pérgamo  
RAL1013

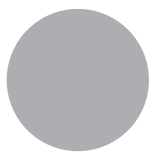

Arena  
RAL1019

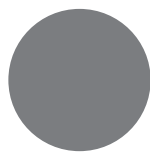

Musgo  
RAL7030

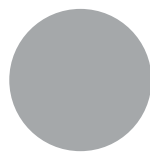

Cemento  
RAL7040

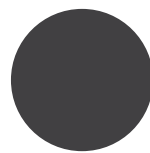

Grafito  
RAL7016

E (cm)	D (cm)	A	B	H	R	kg	V (m3)
80	80	36	42	3	50	34	0,15
90	90	42	53	3	50	43	0,19



E: 80-90

D: 80 - 90

Opcional:



Cromo Brillo

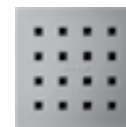

Cromo Mate

Válvula sifónica en polipropileno 90 mm Ø



Desagüe vertical.  
40 L/mn.

VÁLVULAS EN OPCION



PVP: 32€  
desagüe  
horizontal



PVP: 32€  
desagüe  
vertical

Válvula VIEGA 36 L/mn

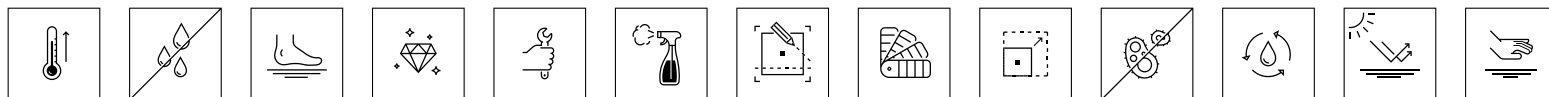

Rejilla de desagüe:

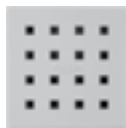

Blanco

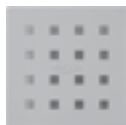

Pérgamo



Grafito

Válvula sifónica en polipropileno 90 mm Ø



Desagüe horizontal.  
40 L/mn.

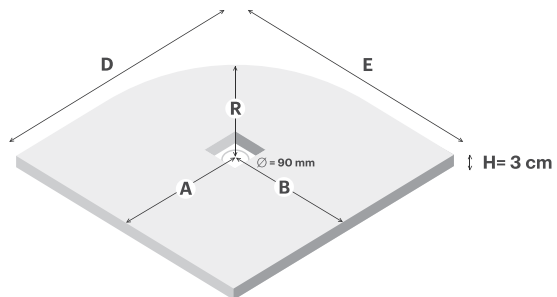

80: A y B = 36 cm.  
90: A y B = 42 cm.  
R = 50 cm.  
H = 3 cm.

Tarifas		
D—E cm.	80	90
80	<b>312 €</b>	—
90	—	<b>312 €</b>

Incrementos	
RAL	<b>70 €</b>
Primer corte	<b>Incluido</b>
Resto de cortes	<b>40 €</b>

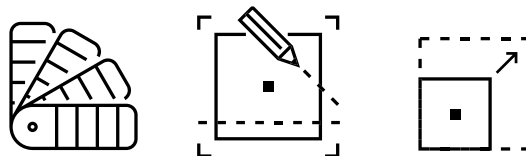

**EN STOCK**

**24H\***

**48H\***

\* salida de fábrica

\* Para pedidos unitarios en el limite del estock disponible

80 x 80

90 x 90

Rejilla del color del plato, Válvula Salida horizontal  
Color Blanco, Grafito, Pérgamo

## LISO SEDA

Textura lisa suave

Standard

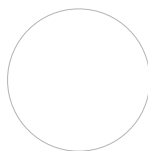

Blanco  
RAL9003

E (cm)	D (cm)	A	B	H	kg	V (m3)
70	100	50	35	3,5	40	0,17
	120	± 43	35	3,5	48	0,20
	140	± 43	35	3,5	56	0,23
	160	± 43	35	3,5	64	0,26
	180	± 43	35	3,5	72	0,29
80	100	50	40	3,5	46	0,19
	120	± 43	40	3,5	55	0,22
	140	± 43	40	3,5	64	0,26
	160	± 43	40	3,5	73	0,29
	180	± 43	40	3,5	83	0,33
90	120	± 43	45	3,5	62	0,25
	140	± 43	45	3,5	72	0,29
	160	± 43	45	3,5	83	0,33
	180	± 43	45	3,5	93	0,37
	200	± 43	45	3,5	100	0,39
100	120	± 43	50	3,5	69	0,27
	140	± 43	50	3,5	80	0,32
	160	± 43	50	3,5	92	0,36
	180	± 43	50	3,5	103	0,40
	200	± 43	50	3,5	114	0,47



E: 70-80-90-100

D: 100 - 180

Opcional:



Cromo Brillo

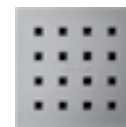

Cromo Mate

Válvula sifónica en polipropileno 90 mm Ø



Desagüe vertical.  
40 L/mn.

VÁLVULAS EN OPCION



PVP: 32€  
desagüe horizontal

PVP: 32€  
desagüe vertical

Válvula VIEGA 36 L/mn

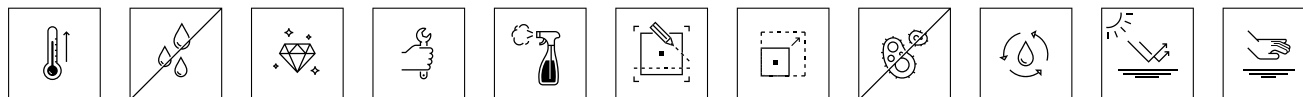

Rejilla de desagüe:



Tapa color del plato  
Rejilla de resina  
Evacuación reducida

Válvula sifónica en polipropileno 90 mm Ø



Desagüe horizontal.  
40 L/mn.

**Tarifas**

D—E cm.	70	80	90	100
100	<b>388 €</b>	<b>416 €</b>		
120	<b>430 €</b>	<b>460 €</b>	<b>490 €</b>	<b>669 €</b>
140	<b>490 €</b>	<b>522 €</b>	<b>554 €</b>	<b>729 €</b>
160	<b>528 €</b>	<b>572 €</b>	<b>616 €</b>	<b>779 €</b>
180	<b>568 €</b>	<b>618 €</b>	<b>668 €</b>	<b>849 €</b>
200			<b>779 €</b>	<b>995 €</b>

**Incrementos**

Primer corte

**Incluido**

Resto de cortes

**40 €**

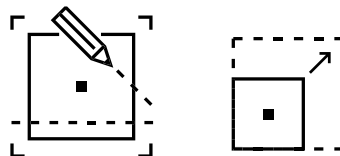
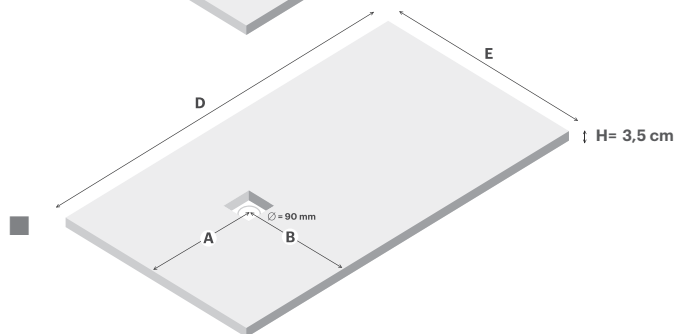
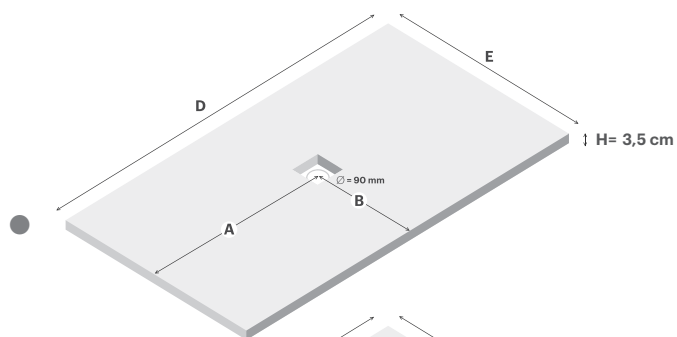

CM	70	80	90	100
100	●	●		
120	■	■	■	■
140	■	■	■	■
160	■	■	■	■
180	■	■	■	■
200			■	■

# LISO

## Textura lisa

Standard

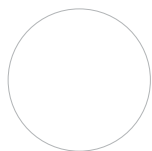

Blanco  
RAL9003



Pérgamo  
RAL1013

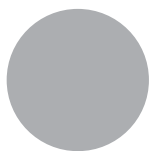

Arena  
RAL1019

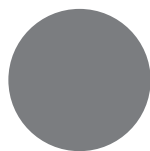

Musgo  
RAL7030



Cemento  
RAL7040

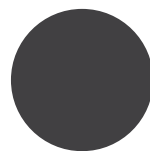

Grafito  
RAL7016

E (cm)	D (cm)	A	B	H	kg	V (m3)
70	90	45	35	3	33	0,15
	100	50	35	3	37	0,17
	120	± 43	35	3	44	0,20
	140	± 43	35	3	51	0,23
	160	± 43	35	3	59	0,26
	180	± 43	35	3	66	0,29
80	100	50	40	3	42	0,19
	120	± 43	40	3	50	0,22
	140	± 43	40	3	59	0,26
	160	± 43	40	3	67	0,29
	180	± 43	40	3	75	0,33
	200	± 43	40	3	84	0,36
90	90	45	45	3	43	0,19
	120	± 43	45	3	47	0,25
	140	± 43	45	3	66	0,29
	160	± 43	45	3	75	0,33
	180	± 43	45	3	85	0,37
	200	± 43	45	3	94	0,40
100	100	50	50	3	52	0,23
	120	± 43	50	3	63	0,27
	140	± 43	50	3	73	0,32
	160	± 43	50	3	84	0,36
	180	± 43	50	3	94	0,40
	210	± 43	50	3	110	0,47
130	140	± 43	65	3	95	0,36
	180	± 43	65	3	122	0,47



E: 70-80-90-100-130

Opcional:



Cromo Brillo

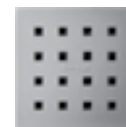

Cromo Mate

Válvula sifónica en polipropileno 90 mm Ø



Desagüe vertical.  
40 L/mn.

VÁLVULAS EN OPCION



PVP: 32€  
desagüe horizontal



PVP: 32€  
desagüe vertical

Válvula VIEGA 36 L/mn

D: 90 - 210

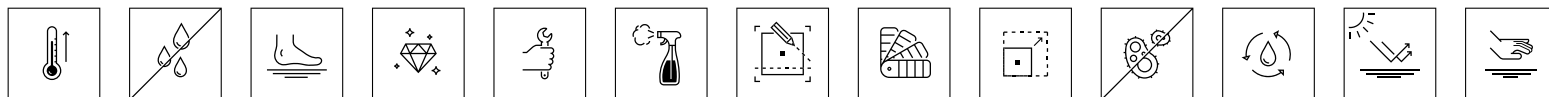



Rejilla de desagüe:

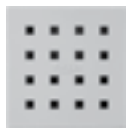

Blanco

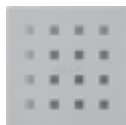

Pérgamo

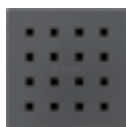

Grafito

Válvula sifónica en polipropileno 90 mm Ø

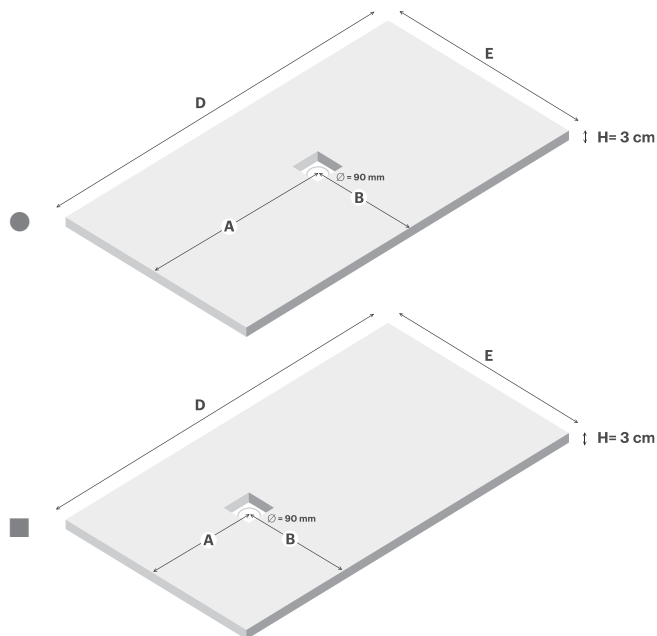
Desagüe horizontal.  
40 L/mn.

CM	70	80	90	100	130
90	●		●		
100	●	●		●	
120	■	■	■	■	
140	■	■	■	■	■
160	■	■	■	■	
180	■	■	■	■	■
200		■	■		
210				■	

## Tarifas

D—E cm.	70	80	90	100	130
90	<b>274 €</b>		<b>312 €</b>		
100	<b>286 €</b>	<b>312 €</b>		<b>474 €</b>	
120	<b>316 €</b>	<b>338 €</b>	<b>398 €</b>	<b>539 €</b>	
140	<b>360 €</b>	<b>384 €</b>	<b>458 €</b>	<b>640 €</b>	<b>796 €</b>
160	<b>388 €</b>	<b>420 €</b>	<b>510 €</b>	<b>699 €</b>	
180	<b>418 €</b>	<b>454 €</b>	<b>578 €</b>	<b>759 €</b>	<b>996 €</b>
200		<b>558 €</b>	<b>658 €</b>		
210				<b>895 €</b>	

## Incrementos

RAL

**70 €**

Primer corte

**Incluido**

Resto de cortes

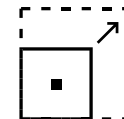
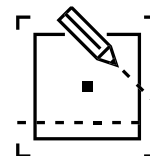
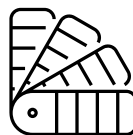
**40 €****EN STOCK****24H\*****48H\***

\* salida de fábrica

\* Para pedidos unitarios en el limite del estock disponible

70 x 90	80 x 100	90 x 90
70 x 100	80 x 120	
70 x 120	80 x 140	
70 x 140	80 x 160	
70 x 160	80 x 180	
70 x 180	80 x 200	

Rejilla del color del plato, Válvula Salida horizontal  
Color Blanco, Grafito, Pérgamo

## LISO ENMARCADO Textura lisa

Standard

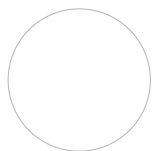

Blanco  
RAL9003



Pérgamo  
RAL1013

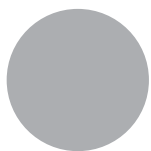

Arena  
RAL1019

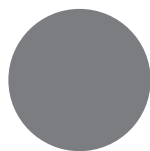

Musgo  
RAL7030

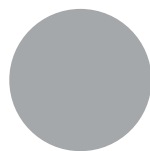

Cemento  
RAL7040

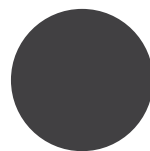

Grafito  
RAL7016

E (cm)	D (cm)	A	B	H	kg	V (m3)
70	100	50	35	5	46	0,17
	120	± 43	35	5	55	0,20
	140	± 43	35	5	64	0,23
	160	± 43	35	5	73	0,26
	180	± 43	35	5	82	0,29

80	100	50	40	5	52	0,19
	120	± 43	40	5	63	0,22
	140	± 43	40	5	73	0,26
	160	± 43	40	5	84	0,29
	180	± 43	40	5	94	0,33
	200	± 43	40	5	104	0,40

90	120	± 43	45	5	71	0,25
	140	± 43	45	5	82	0,29
	160	± 43	45	5	94	0,33
	180	± 43	45	5	106	0,37

100	100	50	50	5	65	0,23
	120	± 43	50	5	78	0,27
	140	± 43	50	5	91	0,32
	160	± 43	50	5	104	0,36
	180	± 43	50	5	117	0,40
	210	± 43	50	5	137	0,44



E: 70-80-90-100

D: 100 - 210

Opcional:



Cromo Brillo

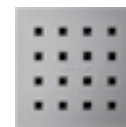

Cromo Mate

Válvula sifónica en polipropileno 90 mm Ø



Desagüe vertical.  
40 L/mn.

VÁLVULAS EN OPCION



PVP: 32€  
desagüe horizontal



PVP: 32€  
desagüe vertical

Válvula VIEGA 36 L/mn

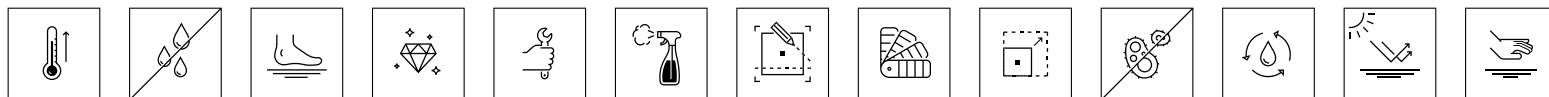

Rejilla de desagüe:

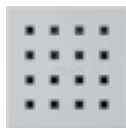

Blanco

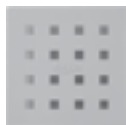

Pérgamo

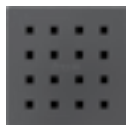

Grafito

Válvula sifónica en polipropileno 90 mm Ø



Desagüe horizontal.  
40 L/mn.

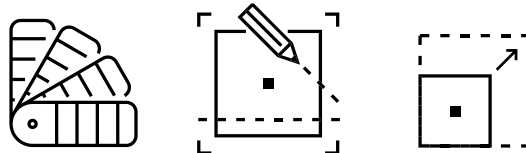
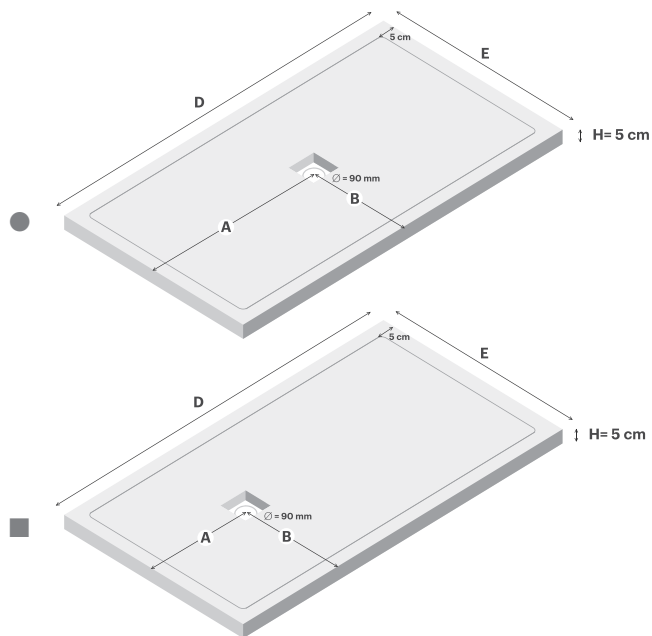

Tarifas

D—E cm.	70	80	90	100
100	<b>388 €</b>	<b>416 €</b>		<b>599 €</b>
120	<b>430 €</b>	<b>460 €</b>	<b>490 €</b>	<b>669 €</b>
140	<b>490 €</b>	<b>522 €</b>	<b>554 €</b>	<b>729 €</b>
160	<b>528 €</b>	<b>572 €</b>	<b>616 €</b>	<b>779 €</b>
180	<b>568 €</b>	<b>618 €</b>	<b>668 €</b>	<b>849 €</b>
200		<b>668 €</b>		
210				<b>949 €</b>

Incrementos

RAL	<b>70 €</b>
Desde el primer corte	<b>120 €</b>

CM	70	80	90	100
100	●	●		●
120	■	■	■	■
140	■	■	■	■
160	■	■	■	■
180	■	■	■	■
200		■		
210				■

## LISO ENMARCADO FRONTAL Textura lisa

Standard

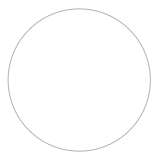

Blanco  
RAL9003



Pérgamo  
RAL1013

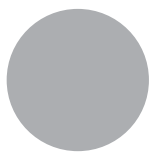

Arena  
RAL1019

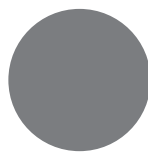

Musgo  
RAL7030

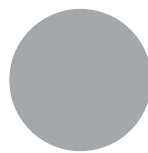

Cemento  
RAL7040

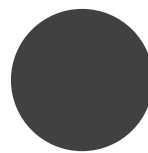

Grafito  
RAL7016

E (cm)	D (cm)	A	B	H	kg	V (m3)
70	100	50	35	5	40	0,17
	120	± 43	35	5	48	0,20
	140	± 43	35	5	56	0,23
	160	± 43	35	5	64	0,26
	180	± 43	35	5	72	0,29

80	100	50	40	5	46	0,19
	120	± 43	40	5	55	0,22
	140	± 43	40	5	64	0,26
	160	± 43	40	5	73	0,29
	180	± 43	40	5	83	0,33
200	± 43	40	5	92	0,36	

90	120	± 43	45	5	62	0,25
	140	± 43	45	5	72	0,29
	160	± 43	45	5	83	0,33
	180	± 43	45	5	93	0,37

100	100	50	50	5	57	0,23
	120	± 43	50	5	69	0,27
	140	± 43	50	5	80	0,32
	160	± 43	50	5	92	0,36
	180	± 43	50	5	103	0,40
	210	± 43	50	5	120	0,44



E: 70-80-90-100

D: 100 - 210

Opcional:



Cromo Brillo

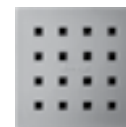

Cromo Mate

Válvula sifónica en polipropileno 90 mm Ø



Desagüe vertical.  
40 L/mn.

VÁLVULAS EN OPCION



PVP: 32€  
desagüe horizontal



PVP: 32€  
desagüe vertical

Válvula VIEGA 36 L/mn

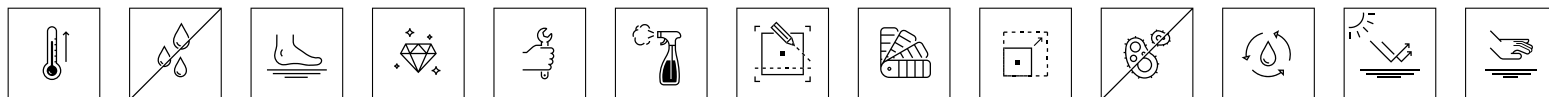

Rejilla de desagüe:

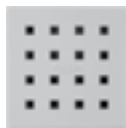

Blanco

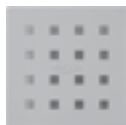

Pérgamo



Grafito

Válvula sifónica en polipropileno 90 mm Ø



Desagüe horizontal.  
40 L/mn.

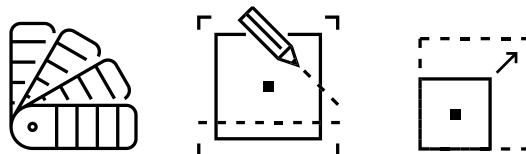
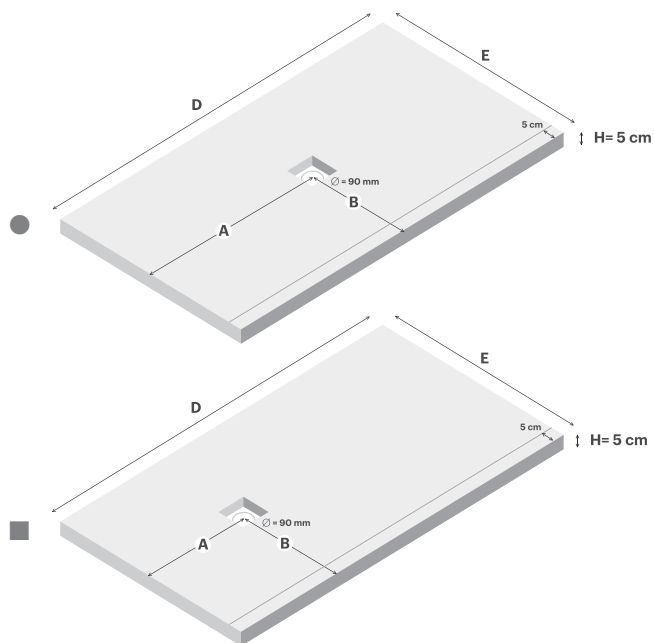

**Tarifas**

A—B cm.	70	80	90	100
100	<b>337 €</b>	<b>361 €</b>		<b>559 €</b>
120	<b>373 €</b>	<b>399 €</b>	<b>426 €</b>	<b>629 €</b>
140	<b>425 €</b>	<b>453 €</b>	<b>480 €</b>	<b>684 €</b>
160	<b>458 €</b>	<b>496 €</b>	<b>534 €</b>	<b>739 €</b>
180	<b>493 €</b>	<b>536 €</b>	<b>604 €</b>	<b>804 €</b>
200		<b>638 €</b>		
210				<b>922 €</b>

**Incrementos**

<b>RAL</b>	<b>70 €</b>
<b>Primer corte</b>	<b>Incluido</b>
<b>Resto de cortes</b>	<b>40 €</b>

\* Indicar la posición de la válvula (derecha o izquierda)

CM	70	80	90	100
100	●	●		●
120	■	■	■	■
140	■	■	■	■
160	■	■	■	■
180	■	■	■	■
200		■		
210				■

## VESUBIO Textura piedra

Standard



Blanco  
RAL9003



Pérgamo  
RAL1013



Arena  
RAL1019



Musgo  
RAL7030



Cemento  
RAL7040



Grafito  
RAL7016

E (cm)	D (cm)	A	B	H	kg	V (m3)
80	100	50	40	3	24	0,19
	120	± 43	40	3	28	0,22
	140	± 43	40	3	33	0,26
	160	± 43	40	3	38	0,29
	180	± 43	40	3	42	0,33
200	± 43	40	3	47	0,33	

90	120	± 43	45	3	32	0,25
	140	± 43	45	3	37	0,29
	160	± 43	45	3	42	0,33
	180	± 43	45	3	48	0,37
	200	± 43	45	3	53	0,40



E: 80-90

D: 100 - 200

Opcional:



Inox

Válvula sifónica en polipropileno 90 mm Ø



Desagüe vertical.  
40 L/mn.

VÁLVULAS EN OPCION



PVP: 32€  
desagüe horizontal

PVP: 32€  
desagüe vertical

Válvula VIEGA 36 L/mn

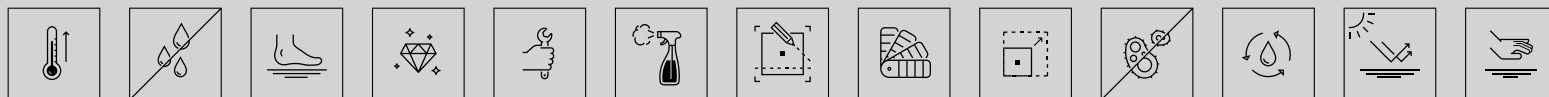

Rejilla de desagüe:



Blanco



Pérgamo



Grafito

Válvula sifónica en polipropileno 90 mm Ø

Desagüe horizontal.  
40 L/mn.

## Tarifas

D—E cm.	80	90
100	<b>342 €</b>	
120	<b>370 €</b>	<b>438 €</b>
140	<b>422 €</b>	<b>504 €</b>
160	<b>462 €</b>	<b>560 €</b>
180	<b>498 €</b>	<b>636 €</b>
200	<b>614 €</b>	<b>724 €</b>

## Incrementos

RAL	<b>70 €</b>
Primer corte	<b>Incluido</b>
Resto de cortes	<b>40 €</b>

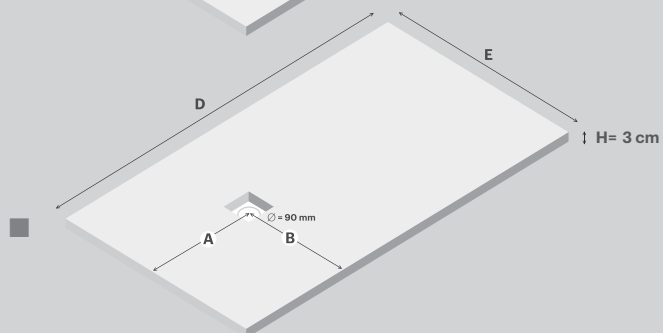
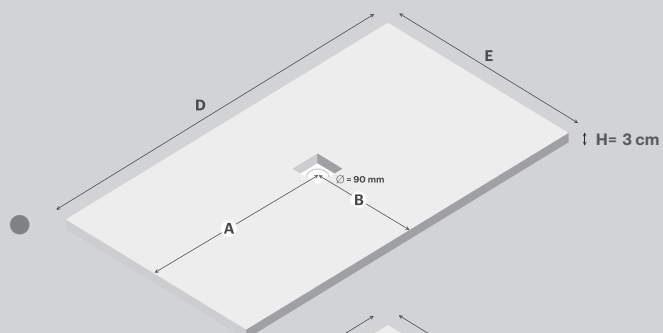
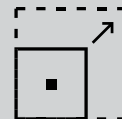
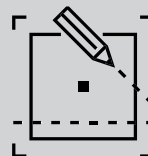
47%  
+ light

CM	80	90
100	●	
120	■	■
140	■	■
160	■	■
180	■	■
200	■	■

## AMIATA Textura piedra

Standard



Blanco  
RAL9003



Pérgamo  
RAL1013



Arena  
RAL1019



Musgo  
RAL7030



Cemento  
RAL7040



Grafito  
RAL7016

E (cm)	D (cm)	A	B	H	kg	V (m3)
70	90	45	35	3,5	21	0,15
	100	50	35	3,5	23	0,17
	120	± 43	35	3,5	27	0,20
	140	± 43	35	3,5	32	0,23
	160	± 43	35	3,5	36	0,26
	180	± 43	35	3,5	41	0,29

80	80	40	40	3,5	21	0,15
	100	50	40	3,5	26	0,19
	120	± 43	40	3,5	31	0,22
	140	± 43	40	3,5	36	0,26
	160	± 43	40	3,5	41	0,29
	180	± 43	40	3,5	46	0,33
	200	± 43	40	3,5	52	0,36

90	90	45	45	3,5	26	0,19
	120	± 43	45	3,5	35	0,25
	140	± 43	45	3,5	41	0,29
	160	± 43	45	3,5	46	0,33
	180	± 43	45	3,5	52	0,37

100	120	± 43	50	3,5	39	0,27
	140	± 43	50	3,5	45	0,32
	160	± 43	50	3,5	52	0,36
	180	± 43	50	3,5	58	0,40
	200	± 43	50	3,5	64	0,47

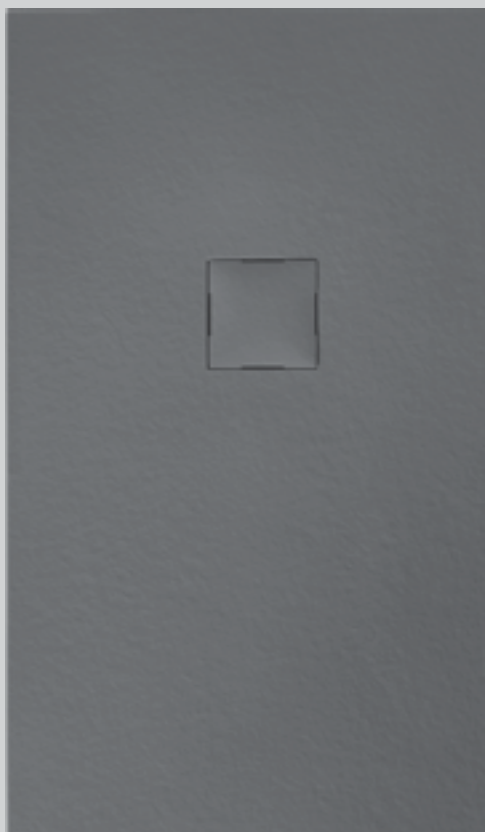

E: 70-80-90-100

D: 80 - 200

Opcional:



Cromo Brillo

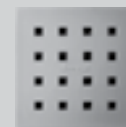

Cromo Mate

Válvula sifónica en polipropileno 90 mm Ø



Desagüe vertical. 40 L/mn.

VÁLVULAS EN OPCION



PVP: 32€  
desagüe horizontal



PVP: 32€  
desagüe vertical

Válvula VIEGA 36 L/mn

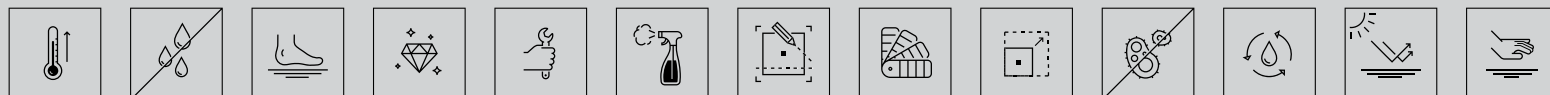



Rejilla de desagüe:



Tapa color del plato  
Rejilla de resina  
Evacuación reducida

Válvula sifónica en  
polipropileno 90 mm Ø



Desagüe horizontal.  
40 L/mn.

## Tarifas

D—E cm.	70	80	90	100
80		<b>336 €</b>		
90	<b>302 €</b>		<b>342 €</b>	
100	<b>314 €</b>	<b>342 €</b>		
120	<b>348 €</b>	<b>370 €</b>	<b>438 €</b>	<b>592 €</b>
140	<b>396 €</b>	<b>422 €</b>	<b>504 €</b>	<b>704 €</b>
160	<b>426 €</b>	<b>462 €</b>	<b>560 €</b>	<b>768 €</b>
180	<b>458 €</b>	<b>498 €</b>	<b>636 €</b>	<b>834 €</b>
200		<b>614 €</b>		<b>984 €</b>

## Incrementos

RAL	<b>70 €</b>
Primer corte	<b>Incluido</b>
Resto de cortes	<b>40 €</b>



47%  
+ light

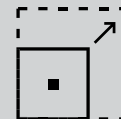
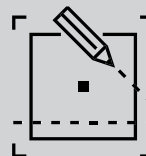
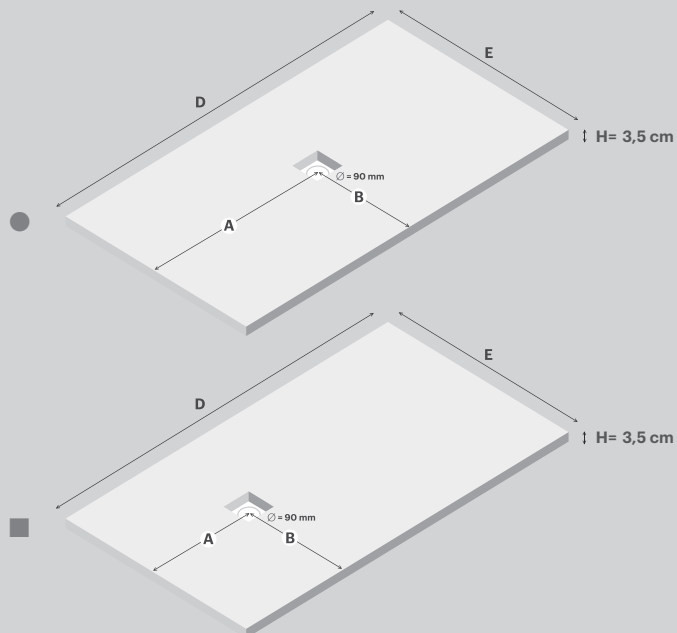

CM	70	80	90	100
80		●		
90	●		●	
100	●	●		
120	■	■	■	■
140	■	■	■	■
160	■	■	■	■
180	■	■	■	■
200		■		■

# STROMBOLI

## Textura piedra

Standard



Blanco  
RAL9003



Pérgamo  
RAL1013



Arena  
RAL1019



Musgo  
RAL7030



Cemento  
RAL7040



Grafito  
RAL7016

E (cm)	D (cm)	A	B	H	kg	V (m3)
80	100	15	40	3,8	30	0,19
	120	15	40	3,8	35	0,22
	140	15	40	3,8	41	0,26
	160	15	40	3,8	47	0,29
	180	15	40	3,8	53	0,33
	200	15	40	3,8	59	0,36
90	100	15	45	3,8	33	0,21
	120	15	45	3,8	40	0,25
	140	15	45	3,8	46	0,29
	160	15	45	3,8	53	0,33
	180	15	45	3,8	59	0,37
	200	15	45	3,8	66	0,40
100	120	15	50	3,8	44	0,27
	140	15	50	3,8	51	0,32
	160	15	50	3,8	59	0,36
	180	15	50	3,8	66	0,40
	200	15	50	3,8	73	0,44



E: 80-90-100

D: 100 - 200

Opcional:



Tapa resina Canto

Válvula sifónica en polipropileno 90 mm Ø



Desagüe vertical.  
40 L/mn.

VÁLVULAS EN OPCION



PVP: 32€  
desagüe horizontal

PVP: 32€  
desagüe vertical

Válvula VIEGA 36 L/mn

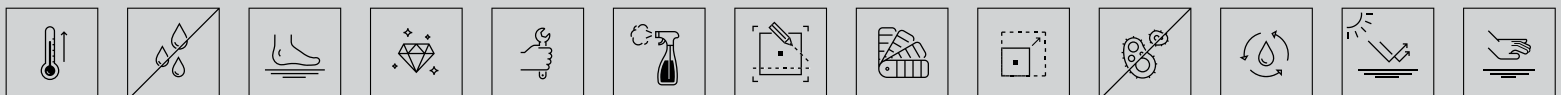

Rejilla de desagüe:

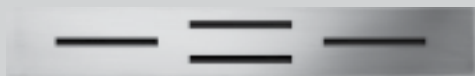

Acero inox 316

Válvula sifónica en polipropileno 90 mm Ø



Desagüe horizontal.  
40 L/mn.

#### Tarifas

D—E cm.	80	90	100
100	<b>386 €</b>	<b>426 €</b>	
120	<b>426 €</b>	<b>504 €</b>	<b>734 €</b>
140	<b>486 €</b>	<b>578 €</b>	<b>810 €</b>
160	<b>530 €</b>	<b>644 €</b>	<b>884 €</b>
180	<b>574 €</b>	<b>730 €</b>	<b>958 €</b>
200	<b>706 €</b>	<b>806 €</b>	<b>1036 €</b>

#### Incrementos

RAL	<b>70 €</b>
Corte solo en largo (maxi. 10 cm)	<b>Incluido</b>



47%  
+ light

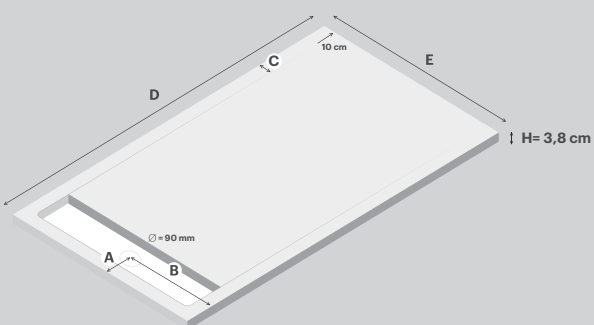
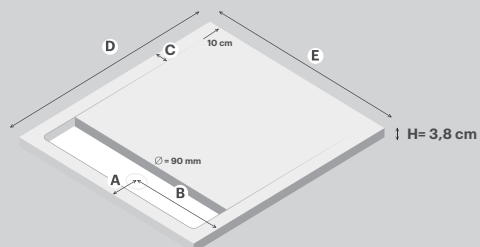
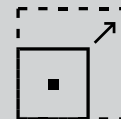
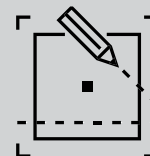
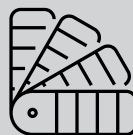

CM	80	90	100
100	●	●	
120	●	●	●
140	●	●	●
160	●	●	●
180	●	●	●
200	●	●	●

# LIPARI

## Textura basalto

Standard



Blanco  
RAL9003



Pérgamo  
RAL1013



Arena  
RAL1019



Musgo  
RAL7030



Cemento  
RAL7040



Grafito  
RAL7016

E (cm)	D (cm)	A	B	H	kg	V (m3)
70	100	50	35	3	21	0,17
	120	± 43	35	3	25	0,20
	140	± 43	35	3	29	0,23
	160	± 43	35	3	33	0,26
	180	± 43	35	3	37	0,29
75	100	50	37,5	3	21	0,17
	120	± 43	37,5	3	25	0,20
	140	± 43	37,5	3	29	0,23
	160	± 43	37,5	3	33	0,26
	180	± 43	37,5	3	37	0,29
80	100	50	40	3	24	0,19
	120	± 43	40	3	28	0,22
	140	± 43	40	3	33	0,26
	160	± 43	40	3	38	0,29
	180	± 43	40	3	42	0,33
90	90	45	45	3	24	0,19
	100	± 43	45	3	27	0,25
	120	± 43	45	3	32	0,25
	140	± 43	45	3	37	0,29
	160	± 43	45	3	42	0,33
100	100	50	50	3	30	0,23
	120	± 43	50	3	35	0,27
	140	± 43	50	3	41	0,32
	160	± 43	50	3	47	0,36
	180	± 43	50	3	53	0,40
200	± 43	50	3	59	0,47	

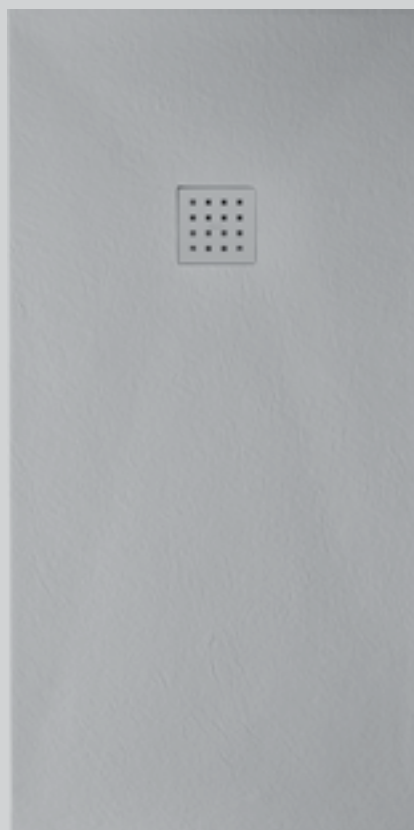

E: 70-75-80-90-100

D: 90 - 200

Opcional:



Cromo Brillo

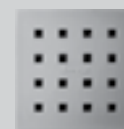

Cromo Mate

Válvula sifónica en polipropileno 90 mm Ø



Desagüe vertical. 40 L/mn.

VÁLVULAS EN OPCION



PVP: 32€  
desagüe horizontal



PVP: 32€  
desagüe vertical

Válvula VIEGA 36 L/mn

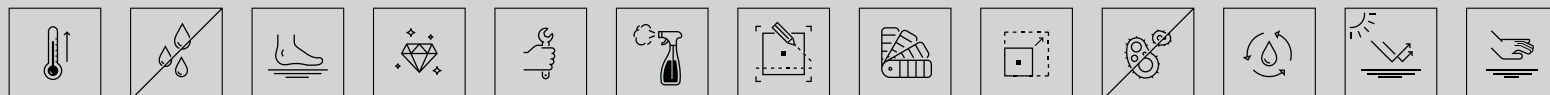

Rejilla de desagüe:



Blanco

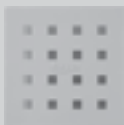

Pérgamo



Grafito

Válvula sifónica en polipropileno 90 mm Ø

Desagüe horizontal.  
40 L/mn.

## Tarifas

D—E cm.	70	75	80	90	100
90				<b>342 €</b>	
100	<b>314 €</b>	<b>342 €</b>	<b>342 €</b>	<b>384 €</b>	<b>520 €</b>
120	<b>348 €</b>	<b>370 €</b>	<b>370 €</b>	<b>438 €</b>	<b>592 €</b>
140	<b>396 €</b>	<b>422 €</b>	<b>422 €</b>	<b>504 €</b>	<b>704 €</b>
160	<b>426 €</b>	<b>462 €</b>	<b>462 €</b>	<b>560 €</b>	<b>768 €</b>
180	<b>458 €</b>	<b>498 €</b>	<b>498 €</b>	<b>636 €</b>	<b>834 €</b>
200					<b>984 €</b>

## Incrementos

RAL

70 €

Primer corte

Incluido

Resto de cortes

40 €

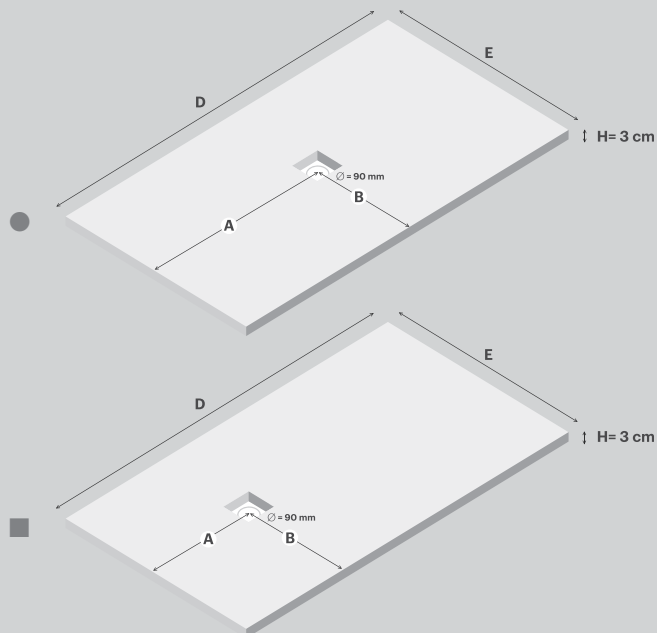
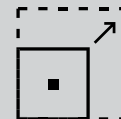
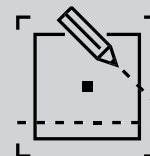
47%  
+ light

CM	70	75	80	90	100
90				●	
100	●	●	●	●	●
120	■	■	■	■	■
140	■	■	■	■	■
160	■	■	■	■	■
180	■	■	■	■	■
200					■

# ETNA

## Textura lisa

Standard



Blanco  
RAL9003



Pérgamo  
RAL1013



Arena  
RAL1019



Musgo  
RAL7030



Cemento  
RAL7040



Grafito  
RAL7016

E (cm)	D (cm)	A	B	H	kg	V (m3)
70	90	45	35	3	19	0,15
	100	50	35	3	21	0,17
	120	± 43	35	3	25	0,20
	140	± 43	35	3	29	0,23
	160	± 43	35	3	33	0,26
	180	± 43	35	3	37	0,29
80	100	50	40	3	24	0,19
	120	± 43	40	3	28	0,22
	140	± 43	40	3	33	0,26
	160	± 43	40	3	38	0,29
	180	± 43	40	3	42	0,33
	200	± 43	40	3	47	0,33
90	90	45	45	3	24	0,17
	120	± 43	45	3	32	0,25
	140	± 43	45	3	37	0,29
	160	± 43	45	3	42	0,33
	180	± 43	45	3	48	0,37
	200	± 43	45	3	53	0,40
100	100	50	50	3	30	0,23
	120	± 43	50	3	35	0,27
	140	± 43	50	3	41	0,32
	160	± 43	50	3	47	0,36
	180	± 43	50	3	53	0,40
	210	± 43	50	3	62	0,47



E: 70-80-90-100-130

D: 90 - 210

Opcional:



Cromo Brillo

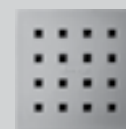

Cromo Mate

Válvula sifónica en polipropileno 90 mm Ø



Desagüe vertical. 40 L/mn.

VÁLVULAS EN OPCION



PVP: 32€  
desagüe horizontal



PVP: 32€  
desagüe vertical

Válvula VIEGA 36 L/mn

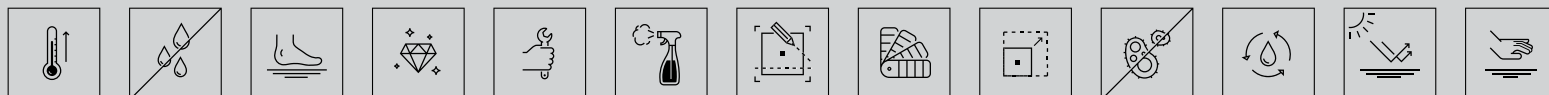

Rejilla de desagüe:



Blanco

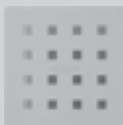

Pérgamo

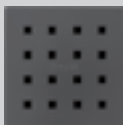

Grafito

Válvula sifónica en polipropileno 90 mm Ø

Desagüe horizontal.  
40 L/mn.

## Tarifas

D—E cm.	70	80	90	100
90	<b>302 €</b>		<b>342 €</b>	
100	<b>314 €</b>	<b>342 €</b>		<b>520 €</b>
120	<b>348 €</b>	<b>370 €</b>	<b>438 €</b>	<b>592 €</b>
140	<b>396 €</b>	<b>422 €</b>	<b>504 €</b>	<b>704 €</b>
160	<b>426 €</b>	<b>462 €</b>	<b>560 €</b>	<b>768 €</b>
180	<b>458 €</b>	<b>498 €</b>	<b>636 €</b>	<b>834 €</b>
200		<b>614 €</b>	<b>724 €</b>	
210				<b>984 €</b>

## Incrementos

RAL

70 €

Primer corte

Incluido

Resto de cortes

40 €

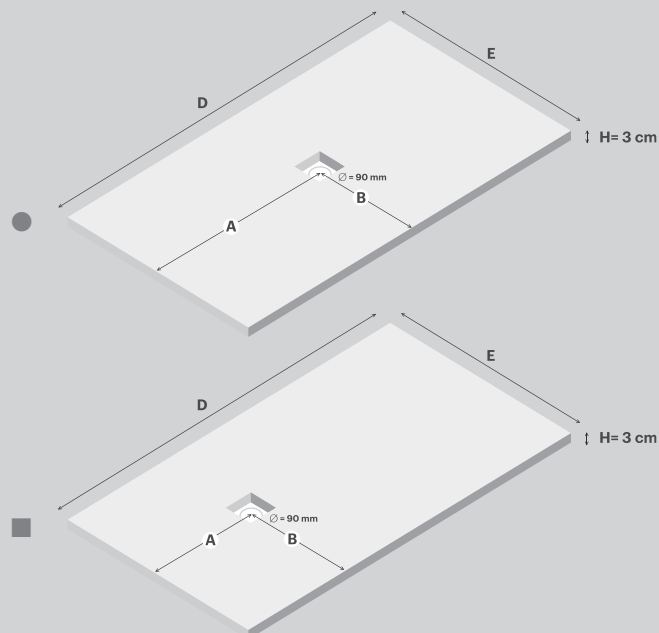
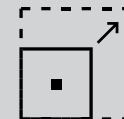
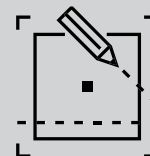
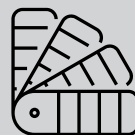
47%  
+ light

CM	70	80	90	100
90	●		●	
100	●	●		●
120	■	■	■	■
140	■	■	■	■
160	■	■	■	■
180	■	■	■	■
200		■	■	
210				■

## PANELES MURALES RESINA

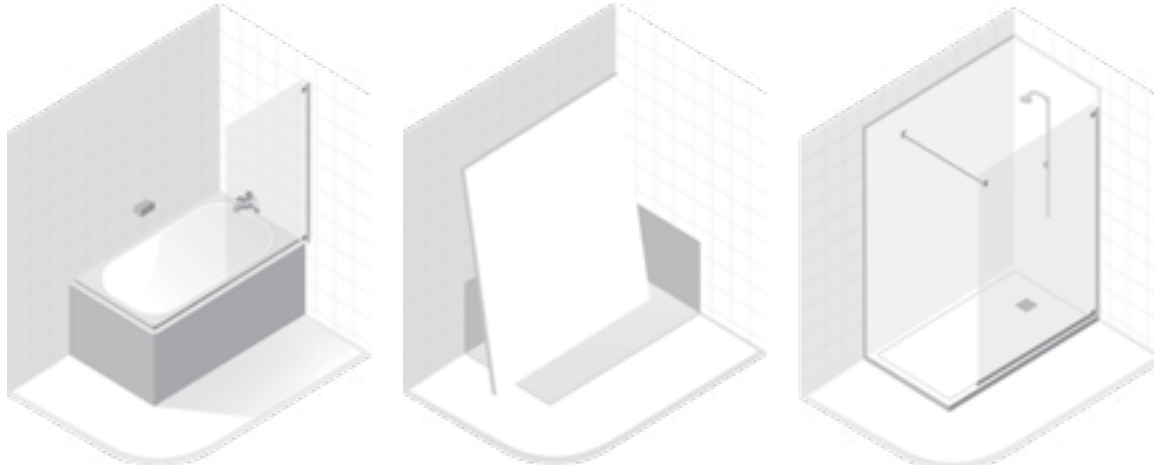

### Standard



Blanco  
RAL9003

Pérgamo  
RAL1013

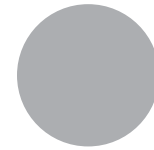

Arena  
RAL1019

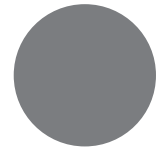

Musgo  
RAL7030

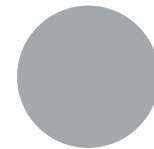

Cemento  
RAL7040

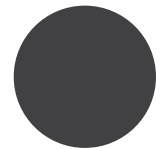

Grafito  
RAL7016

Ponemos a su disposición placas decorativas, de varias medidas y en seis colores: Blanco, pérgamo, grafito, cemento, musgo y arena. Para cubrir sus necesidades puede dar libertad a su imaginación y combinar color y tamaño para obtener el acabado deseado. Permitiendo además, de una simple manera, la transformación de una bañera en un agradable espacio ducha.



Pizarra



Liso

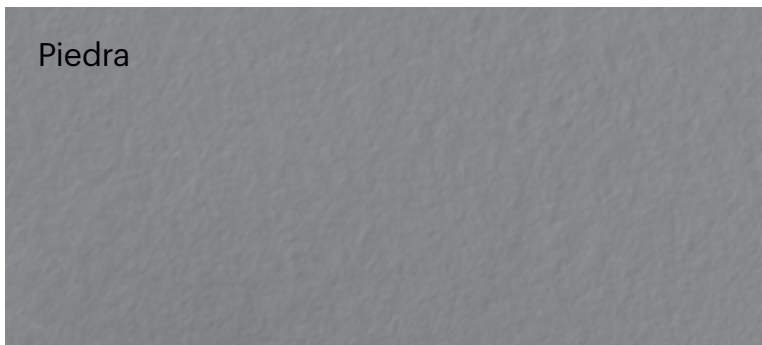

Piedra



Liso Seda

— Sólo blanco—

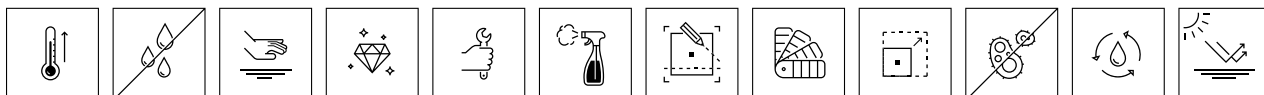





Perfil con forma Z y con forma T (Blanco / Cromo)

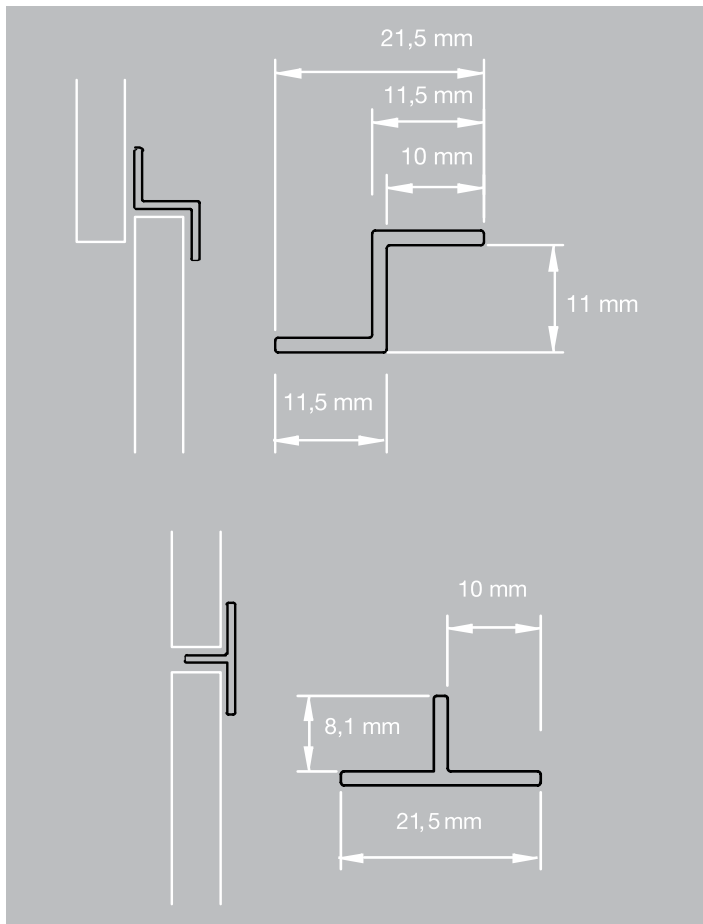

## PIZARRA

### Textura pizarra

Standard

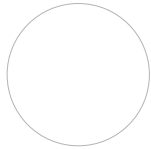

Blanco  
RAL9003



Pérgamo  
RAL1013

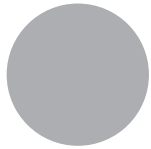

Arena  
RAL1019

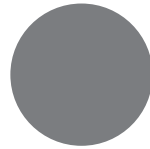

Musgo  
RAL7030

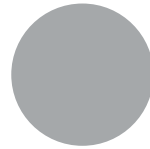

Cemento  
RAL7040

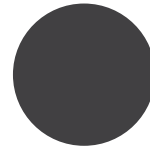

Grafito  
RAL7016

#### Tarifas

A—B cm.	70-80 cm	81-142 cm	143-182 cm	183-210 cm
60 cm	<b>79 €</b>	<b>140 €</b>	<b>179 €</b>	<b>208 €</b>
61-80 cm	<b>115 €</b>	<b>195 €</b>	<b>255 €</b>	<b>277 €</b>
81-100 cm	<b>139 €</b>	<b>245 €</b>	<b>347 €</b>	<b>379 €</b>

Incremento por cambio de color (carta RAL)

**32 € / ud.**

Perfil de aluminio (largo máximo: 210cm) Blanco

**12 € m/l**

Perfil de aluminio (largo máximo: 210cm) Cromo

**24 € m/l**

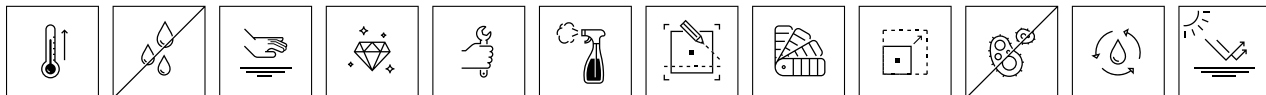
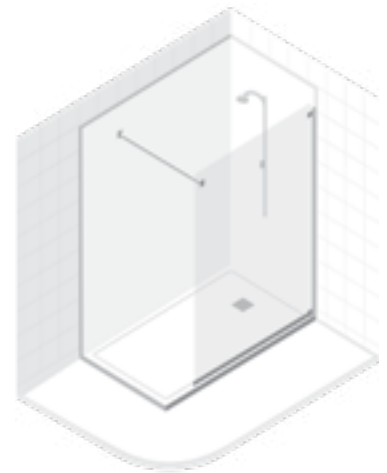

## LISO

### Textura lisa

Standard

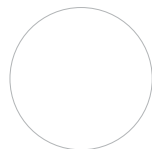

Blanco  
RAL9003



Pégamo  
RAL1013

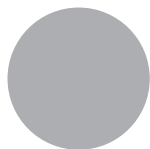

Arena  
RAL1019

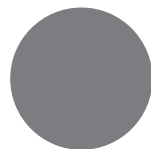

Musgo  
RAL7030

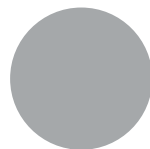

Cemento  
RAL7040

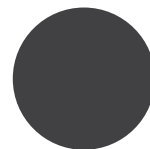

Grafito  
RAL7016

#### Tarifas

A—B cm.	70-80 cm	81-142 cm	143-182 cm	183-210 cm
60 cm	<b>79 €</b>	<b>140 €</b>	<b>179 €</b>	<b>208 €</b>
61-80 cm	<b>115 €</b>	<b>195 €</b>	<b>255 €</b>	<b>277 €</b>
81-100 cm	<b>139 €</b>	<b>245 €</b>	<b>347 €</b>	<b>379 €</b>

Incremento por cambio de color (carta RAL)

**32 € / ud.**

Perfil de aluminio (largo máximo: 210cm) Blanco

**12 € m/l**

Perfil de aluminio (largo máximo: 210cm) Cromo

**24 € m/l**

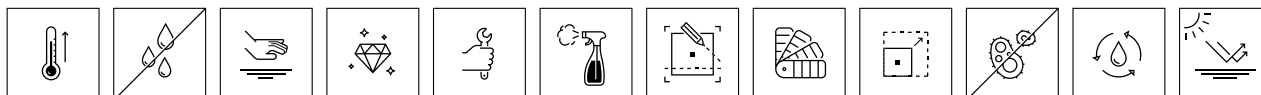
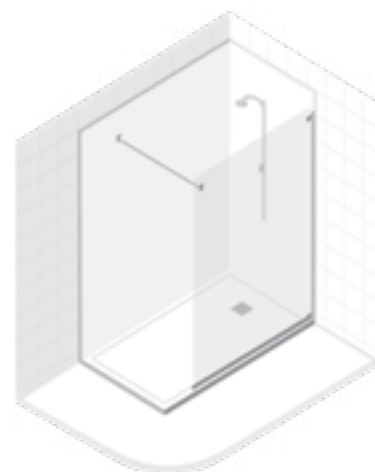

## PIEDRA

### Textura piedra

Standard

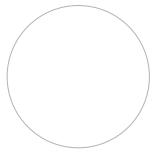

Blanco  
RAL9003



Pérgamo  
RAL1013

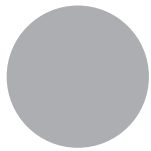

Arena  
RAL1019

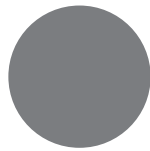

Musgo  
RAL7030

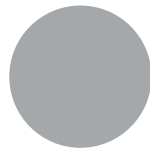

Cemento  
RAL7040

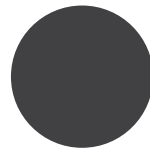

Grafito  
RAL7016

#### Tarifas

A—B cm.	70-80 cm	81-142 cm	143-182 cm	183-210 cm
60 cm	<b>79 €</b>	<b>140 €</b>	<b>179 €</b>	<b>208 €</b>
61-80 cm	<b>115 €</b>	<b>195 €</b>	<b>255 €</b>	<b>277 €</b>
81-100 cm	<b>139 €</b>	<b>245 €</b>	<b>347 €</b>	<b>379 €</b>

Incremento por cambio de color (carta RAL)

**32 € / ud.**

Perfil de aluminio (largo máximo: 210cm) Blanco

**12 € m/l**

Perfil de aluminio (largo máximo: 210cm) Cromo

**24 € m/l**

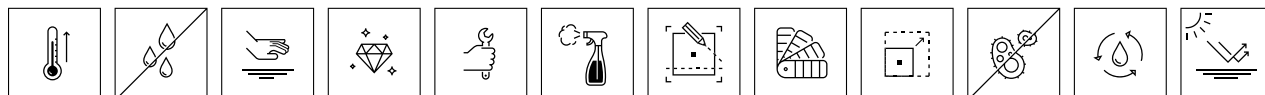
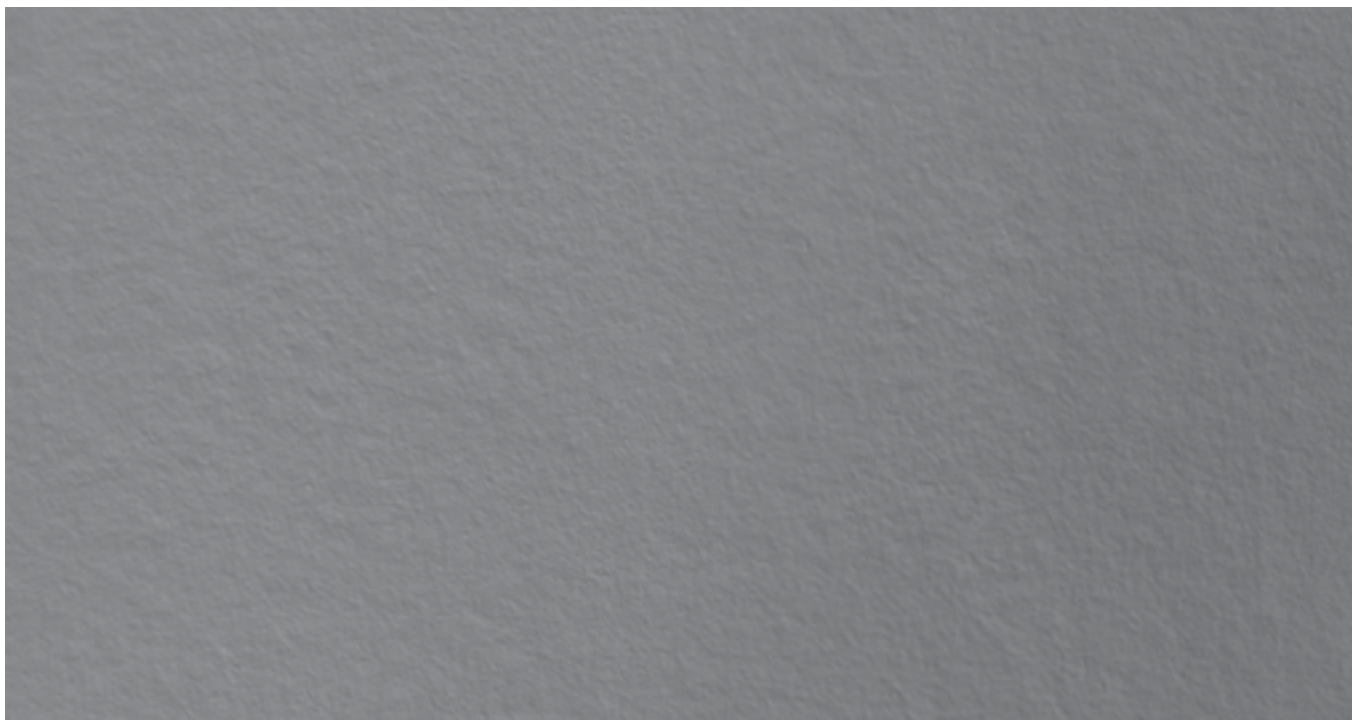
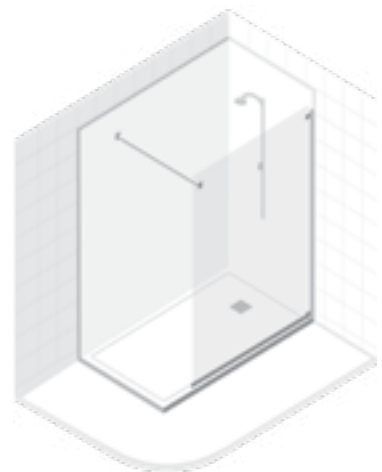

## LISO SEDA

lisa suave

Standard

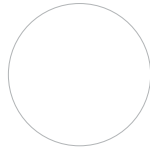

Blanco  
RAL9003

### Tarifas

A—B cm.	70-80 cm	81-142 cm	143-182 cm	183-210 cm
60 cm	<b>79 €</b>	<b>140 €</b>	<b>179 €</b>	<b>208 €</b>
61-80 cm	<b>115 €</b>	<b>195 €</b>	<b>255 €</b>	<b>277 €</b>
81-100 cm	<b>139 €</b>	<b>245 €</b>	<b>347 €</b>	<b>379 €</b>

Perfil de aluminio (largo máximo: 210cm)	Blanco	<b>12 € m/l</b>
Perfil de aluminio (largo máximo: 210cm)	Cromo	<b>24 € m/l</b>

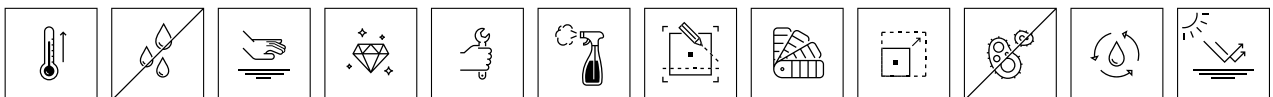
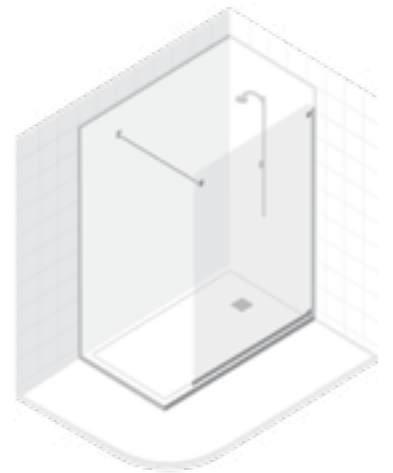

## PLACA XXL FENÓLICA

### Textura natural

Standard

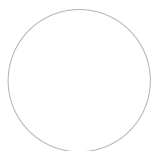

Blanco  
RAL9003



Pérgamo  
RAL1013

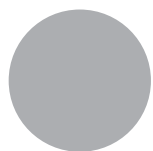

Arena  
RAL1019

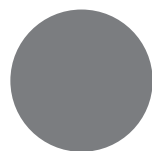

Musgo  
RAL7030

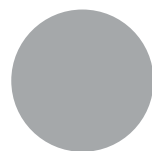

Cemento  
RAL7040

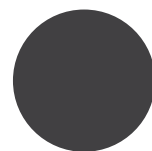

Grafito  
RAL7016

## 8 mm espesor

Tarifas							
A—B cm.	60-100 cm	101-130 cm	131-160 cm	161-180 cm	181-210 cm	211-240 cm	241-260 cm
60-75 cm	<b>150 €</b>	<b>195 €</b>	<b>240 €</b>	<b>270 €</b>	<b>315 €</b>	<b>360 €</b>	<b>390 €</b>
76-100 cm	<b>200 €</b>	<b>260 €</b>	<b>320 €</b>	<b>360 €</b>	<b>420 €</b>	<b>480 €</b>	<b>520 €</b>
101-120 cm	<b>240 €</b>	<b>312 €</b>	<b>384 €</b>	<b>432 €</b>	<b>504 €</b>	<b>576 €</b>	<b>624 €</b>
121-140 cm	<b>280 €</b>	<b>364 €</b>	<b>448 €</b>	<b>504 €</b>	<b>588 €</b>	<b>672 €</b>	<b>728 €</b>
141-160 cm	<b>320 €</b>	<b>416 €</b>	<b>512 €</b>	<b>576 €</b>	<b>672 €</b>	<b>768 €</b>	<b>832 €</b>

Incremento por cambio de color (carta RAL)

**32 € / ud.**

## 4 mm espesor

Cambio de espesor

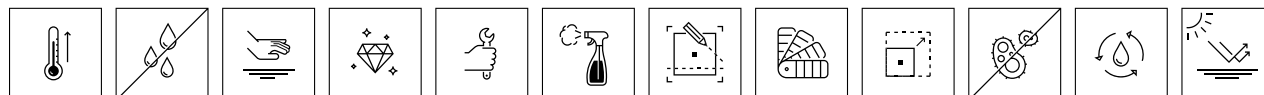
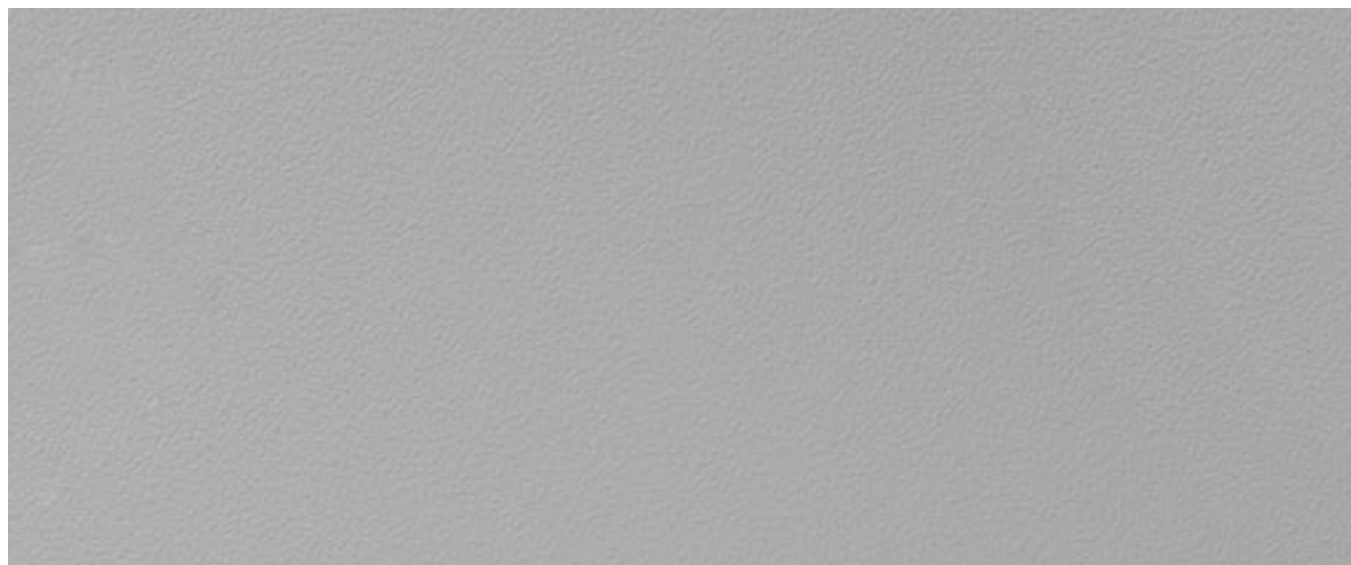
**40 € / ud.**



Placa XXL fenólica con tecnología **Doccia nano-coating®**.

### *Posibilidades infinitas*

Doccia® Nano-particles es el resultado de años de investigación y desarrollo.

Gracias a la introducción de la tecnología de nanopartículas, hoy es posible producir un revestimiento de paneles murales de grandes dimensiones, hasta de 2000×3600 mm. y de grosor más fino, de hasta 4 mm, que mantiene las propiedades mecánicas y estéticas propias de los materiales fenólicos.

Nuestros paneles fenólicos están recubiertos de grafeno mediante la implementación de la tecnología Doccia® Nano-particles patentada.

- **Resistente al agua, a la humedad y a altos grados de vapor.**
- **Altamente resistente a muchos productos químicos.**
- **Instalación, montaje y ensamblaje funcionales.**
- **Higiénico**
- **Superficie no tóxica**
- **Altamente resistente al impacto y rayado**
- **Decorativo y estético con una amplia gama de colores.**

# PRODUCTO EN STOCK

## ENCIMERAS ST STANDARD

HOLBOX ST

MUCURA ST

LEVISA ST

ROATAN ST

### HOLBOX ST



Para Suspender 1 seno



Para Suspender 2 seno



Para Suspender 1 seno



Para Suspender 2 seno



# PRODUCTO EN STOCK



Blanco  
RAL9003



Textura lisa



Disponibles  
de 24 a 48 horas



Servicio  
inmediato

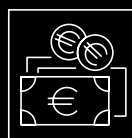

Precios  
económicos

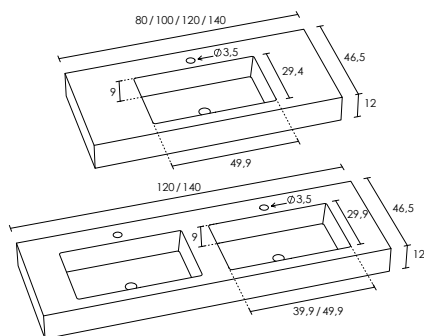

HOLBOX ST	Referencia	Medidas	nº Senos	Seno	PVP
Con faldon	HOLST01C1	800x465x120	1	499x294x90	390 €
	HOLST02C1	1000x465x120	1	499x294x90	438 €
	HOLST03C1	1200x465x120	1	499x294x90	518 €
	HOLST03C2	1200x465x120	2	399x294x90	598 €
	HOLST04C1	1400x465x120	1	499x294x90	598 €
	HOLST04C2	1400x465x120	2	499x294x90	738 €

\* Taladro grifería por defecto.

\* Escuadras de fijación incluidas.

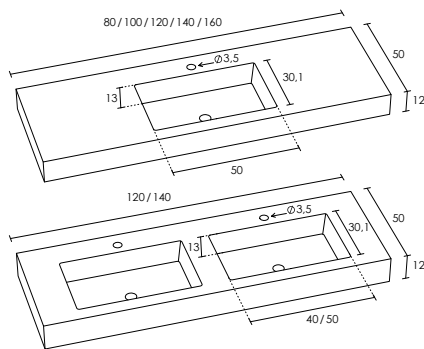

HOLBOX LARGE ST	Referencia	Medidas	nº Senos	Seno	PVP
Con faldon	HLAST01C1	800x500x120	1	500x301x130	430 €
	HLAST02C1	1000x500x120	1	500x301x130	478 €
	HLAST03C1	1200x500x120	1	500x301x130	556 €
	HLAST03C2	1200x500x120	2	400x301x130	638 €
	HLAST04C1	1400x500x120	1	500x301x130	638 €
	HLAST04C2	1400x500x120	2	500x301x130	732 €
HLAST05C1	1600x500x120	1	500x301x130	822 €	

\* Taladro grifería por defecto.

\* Escuadras de fijación incluidas.

# PRODUCTOS EN STOCK

## ENCIMERAS ST STANDARD

### MUCURA ST



Sobre Mueble sin Faldón



Para Suspende con Faldón

### LEVISA ST



Sobre Mueble sin Faldón



Para Suspende con Faldón

### ROATAN ST



Sobre Mueble sin Faldón



Para Suspende con Faldón

# PRODUCTOS EN STOCK



Blanco  
RAL9003



Textura lisa

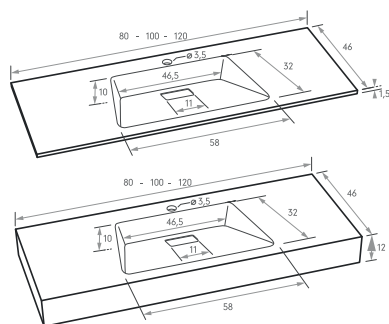

<b>MUCURA ST</b>	<b>Referencia</b>	<b>Medidas</b>	<b>nº Senos</b>	<b>Seno</b>	<b>PVP</b>
Sin Faldon	MUCST01S1	<b>800x460x19</b>	1	<b>585x350x110</b>	<b>420 €</b>
	MUCST02S1	<b>1000x460x19</b>	1	<b>585x350x110</b>	<b>460 €</b>
	MUCST03S1	<b>1200x460x19</b>	1	<b>585x350x110</b>	<b>520 €</b>
Con faldon	MUCST01C1	<b>800x460x120</b>	1	<b>585x350x110</b>	<b>580 €</b>
	MUCST02C1	<b>1000x460x120</b>	1	<b>585x350x110</b>	<b>620 €</b>
	MUCST03C1	<b>1200x460x120</b>	1	<b>585x350x110</b>	<b>680 €</b>

\* Taladro grifería por defecto.

\* Escuadras de fijación incluidas (para modelo con faldón).

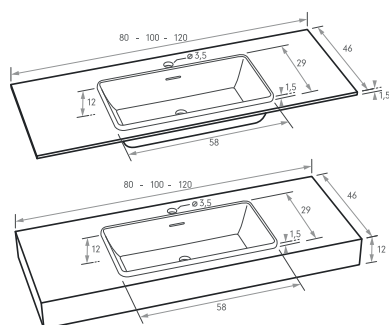

<b>LEVISA ST</b>	<b>Referencia</b>	<b>Medidas</b>	<b>nº Senos</b>	<b>Seno</b>	<b>PVP</b>
Sin Faldon	LEVST01S1	<b>800x460x19</b>	1	<b>580x290x120</b>	<b>420 €</b>
	LEVST02S1	<b>1000x460x19</b>	1	<b>580x290x120</b>	<b>460 €</b>
	LEVST03S1	<b>1200x460x19</b>	1	<b>580x290x120</b>	<b>520 €</b>
Con faldon	LEVST01C1	<b>800x460x120</b>	1	<b>580x290x120</b>	<b>580 €</b>
	LEVST02C1	<b>1000x460x120</b>	1	<b>580x290x120</b>	<b>620 €</b>
	LEVST03C1	<b>1200x460x120</b>	1	<b>580x290x120</b>	<b>680 €</b>

\* Taladro grifería por defecto.

\* Escuadras de fijación incluidas (para modelo con faldón).

\* Incluye adaptador de rebosadero.

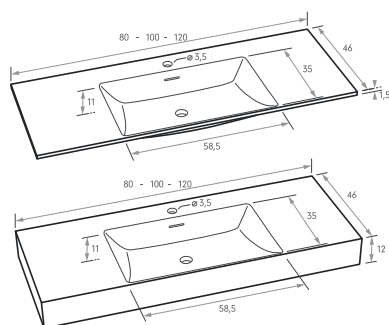

<b>ROATAN ST</b>	<b>Referencia</b>	<b>Medidas</b>	<b>nº Senos</b>	<b>Seno</b>	<b>PVP</b>
Sin Faldon	ROAST01S1	<b>800x460x19</b>	1	<b>580x320x100</b>	<b>420 €</b>
	ROAST02S1	<b>1000x460x19</b>	1	<b>580x320x100</b>	<b>460 €</b>
	ROAST03S1	<b>1200x460x19</b>	1	<b>580x320x100</b>	<b>520 €</b>
Con faldon	ROAST01C1	<b>800x460x120</b>	1	<b>580x320x100</b>	<b>580 €</b>
	ROAST02C1	<b>1000x460x120</b>	1	<b>580x320x100</b>	<b>620 €</b>
	ROAST03C1	<b>1200x460x120</b>	1	<b>580x320x100</b>	<b>680 €</b>

\* Taladro grifería por defecto.

\* Escuadras de fijación incluidas (para modelo con faldón).

\* Incluye adaptador de rebosadero.

# SAONA

## Textura lisa

Standard

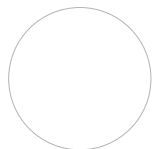
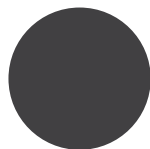

Textura lisa

Blanco  
RAL9003Grafito  
RAL7016

Seno M estandar



Doble seno M estandar



Seno S



Seno L



Seno XL



Seno XXL



Seno Ovalado



Seno PMR





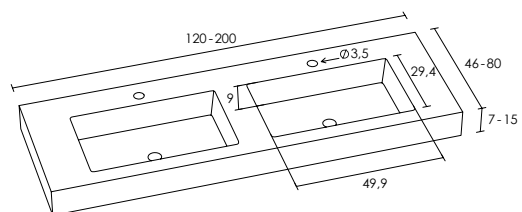
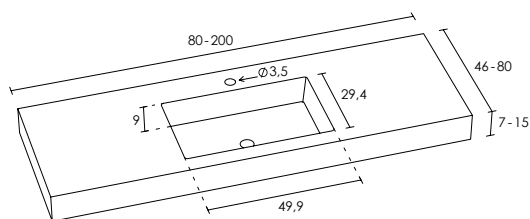

### tarifas

Medidas	nº Senos	Seno M (mm)	PVP
600-700	1	499x294x90	444 €
710-800	1	499x294x90	470 €
810-900	1	499x294x90	494 €
910-1000	1	499x294x90	518 €
1010-1100	1	499x294x90	558 €
1110-1200	1	499x294x90	596 €
1210-1400	1	499x294x90	676 €
1410-1600	1	499x294x90	756 €
1610-1800	1	499x294x90	838 €
1810-2000	1	499x294x90	920 €

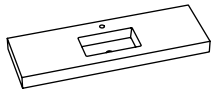
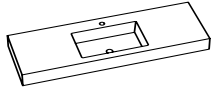
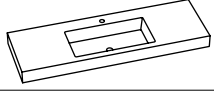
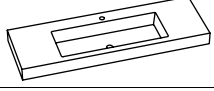
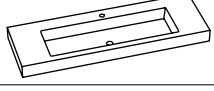
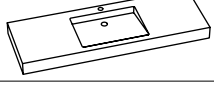
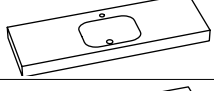

- 2 escuadras de fijación incluidas.
- Taladro de grifería por defecto.
- Facilitar plano de la encimera.
- No se harán los taladros únicamente bajo petición.

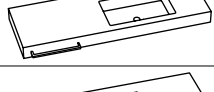
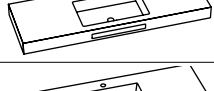
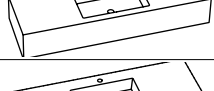
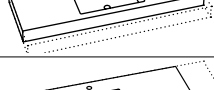
## Incrementos de acabados

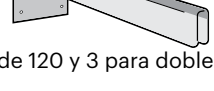
Opciones		Dimens. Seno (mm)	Faldón mínimo	PVP
Seno S		415x255x80	100	Gratuito
Seno M		499x294x90	115	Gratuito
Seno L		600x300x100	130	96 €
Seno XL		800x300x100	130	96 €
Seno XXL		960x300x90	130	96 €
Seno PMR		500x350x60	100	96 €
Seno Ovalado		420x300x90	100	42 €
Doble Seno				96 €
Ral				82 €
Blanco Brillo				82 €
Seno Desplazado				42 €
Toallero metálico		350x20	100	42 € por unidad
Toallero Integrado		400x40	100	42 € por unidad
Altura Faldón			70 a 150	82 €
Fondo especial		460 a 800		82 €
Largo especial		maxi. 2300		42 € por cada 10 cm
Copete		50x19		48 € por M/L
Escuadra		370x200		24 € por unidad

\* Se aconseja 4 escuadras a partir de 120 y 3 para doble seno.

# MAUI

## Textura lisa

Standard

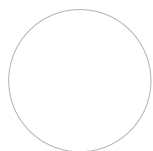
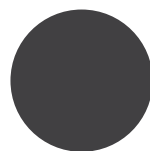

Textura lisa

Blanco  
RAL9003Grafito  
RAL7016

Seno M estandar



Doble seno M estandar



Seno S



Seno L



Seno XL



Seno XXL



Seno Ovalado



Seno PMR





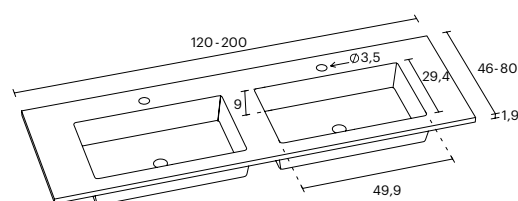
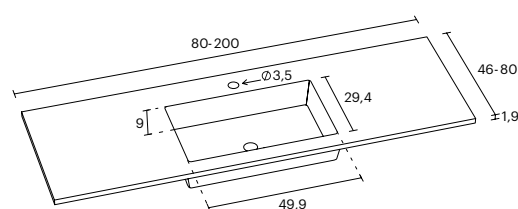

### tarifas

Medidas	nº Senos	Seno M (mm)	PVP
600-710	1	499x294x90	258 €
711-810	1	499x294x90	278 €
811-910	1	499x294x90	298 €
911-1010	1	499x294x90	318 €
1011-1110	1	499x294x90	338 €
1111-1210	1	499x294x90	358 €
1211-1410	1	499x294x90	378 €
1411-1610	1	499x294x90	398 €
1611-1810	1	499x294x90	440 €
1811-2000	1	499x294x90	480 €

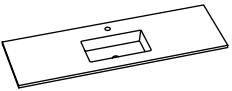
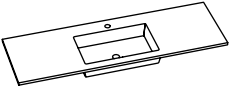
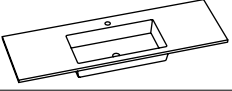
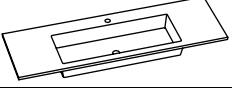
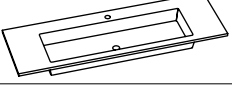
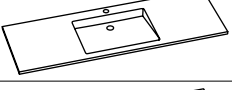
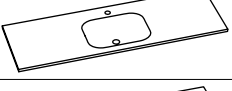

- Taladro de grifería por defecto.
- Facilitar plano de la encimera.
- No se harán los taladros únicamente bajo petición.

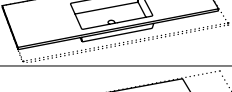
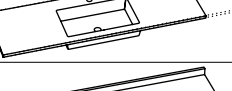
## Incrementos de acabados

Opciones		Dimens. Seno (mm)	PVP
Seno S		415x255x80	gratuito
Seno M		499x294x90	gratuito
Seno L		600x300x100	96 €
Seno XL		800x300x100	96 €
Seno XXL		960x300x90	96 €
Seno PMR		500x350x60	96 €
Seno Ovalado		420x300x90	42 €
Doble Seno			96 €
Ral			82 €
Blanco Brillo			82 €
Seno Desplazado			gratuito
Fondo especial		460 a 800	42 €
Largo especial		maxi. 2300	22 € por cada 10 cm
Copete		50x19	48 € por M/L

## BALAVU / BONDI

Textura lisa

Standard

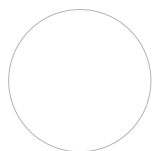
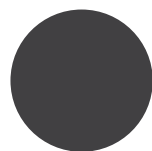

Textura lisa

Blanco  
RAL9003Grafito  
RAL7016

BALAVU Simple



BALAVU Toallero integrado



BALAVU Toallero metálico



BONDI Simple



BONDI Copete

## tarifas





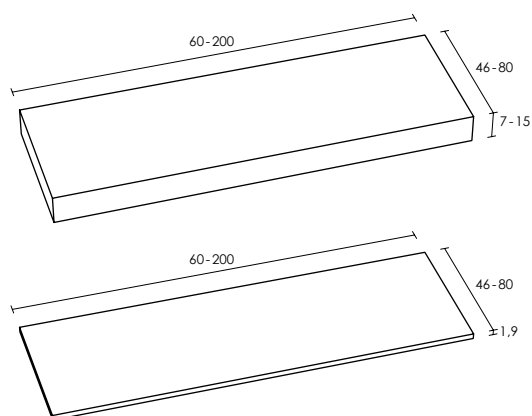

Medidas	Faldón BALAVU	Espesor BONDI	Agujero grifería	PVP BALAVU	PVP BONDI
600-810	100	19	no	346 €	212 €
811-910	100	19	no	370 €	233 €
911-1010	100	19	no	394 €	252 €
1011-1110	100	19	no	435 €	272 €
1111-1210	100	19	no	472 €	293 €
1211-1410	100	19	no	552 €	312 €
1411-1610	100	19	no	632 €	332 €
1611-1810	100	19	no	713 €	373 €
1811-2000	100	19	no	795 €	414 €

- 2 escuadras de fijación incluidas (Balavu).
- Se harán los taladros según pedido expreso.
- Facilitar plano de la encimera.



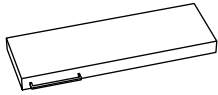
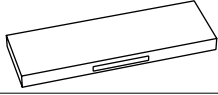

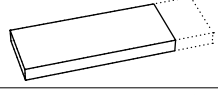
## Incrementos de acabados

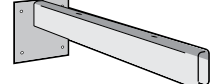
Opciones		Dimensiones (mm)	Faldón mínimo	BALAVU PVP	BONDI PVP
Taladros	Según indicaciones			gratuito	gratuito
Ral				82 €	82 €
Blanco Brillo				82 €	82 €
Toallero metalico		350x20	100	42 € por unidad	
Toallero Integrado		400x40	100	42 € por unidad	
Fondo especial		460 a 800		82 €	42 €
Largo especial		maxi. 2300		42 € por cada 10 cm	22 € por cada 10 cm
Copete		50x19		48 € por M/L	48 € por M/L
Escuadra		370x200		24 € por unidad	

\* Se aconseja 4 escuadras a partir de 120 y 3 para doble seno.

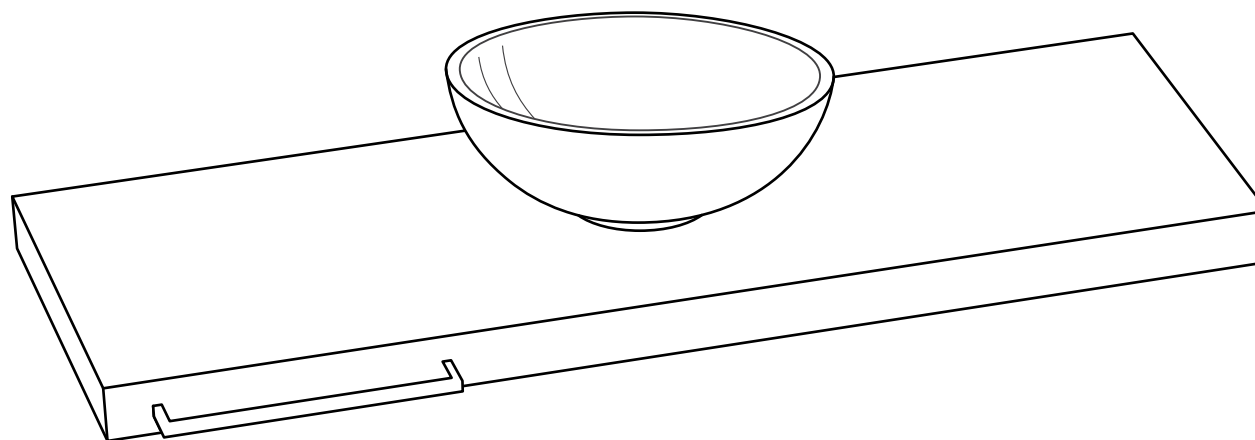

## LAVABOS Textura lisa

Standard

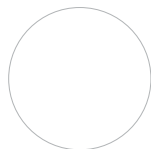

Blanco  
RAL9003

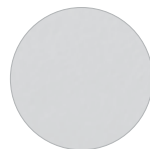

Textura lisa



### LAVABO SOBRE ENCIMERA

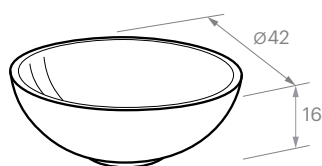

CALIPSO

Blanco **178 €**  
Color **238 €**

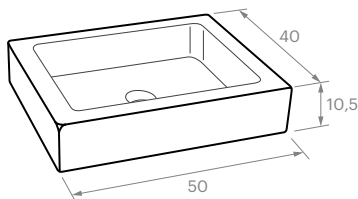

GALATEA

Blanco **178 €**  
Color **238 €**

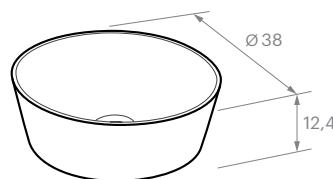

ACIS

Blanco **178 €**  
Color **238 €**

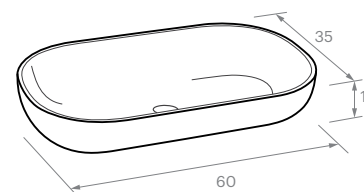

NEREIDA

Blanco **178 €**  
Color **238 €**

### LAVABO ENCASTRADO

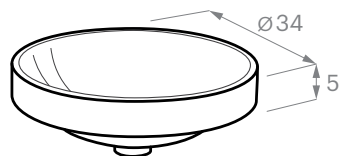

JUNO

Blanco **178 €**  
Color **238 €**

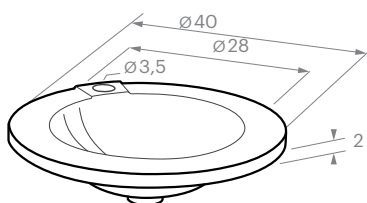

LARES

Blanco **178 €**  
Color **238 €**

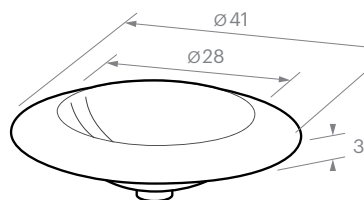

CORUS

Blanco **178 €**  
Color **238 €**

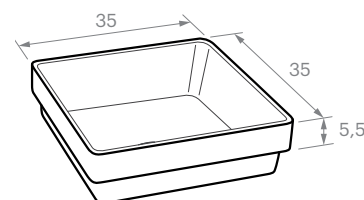

CAMENA

Blanco **178 €**  
Color **238 €**

## GUADA / LUPE

Standard

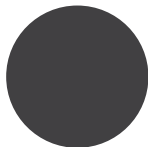
Negro  
MATEEncimera resina  
No incluida

Cierre amortiguado



Mueble ensamblado

## GUADA

Medida	Color	Estructura (mm)	Color Cajón	PVP*
800	Negro Mate	800x460x860	Blanco	862 €
1000	Negro Mate	1000x460x860	Blanco	900 €

\* No se puede cambiar el color de la estructura metalica. Aluminio soldado y termolacado

\* Precio solo de la estructura. Sumar el precio de la encimera elejida.

\* Estructura prevista para la encimera sin faldón

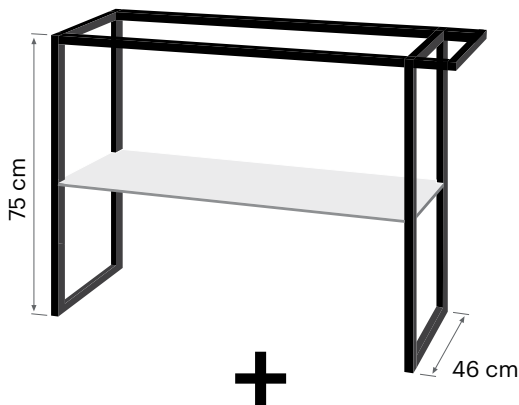
Encimera resina  
No incluida

## LUPE

Medida	Color	Estructura (mm)	Color Balda	PVP
800	Negro Mate	800x460x750	Blanco	442 €
1000	Negro Mate	1000x460x750	Blanco	490 €

\* No se puede cambiar el color de la estructura metalica. Aluminio soldado y termolacado

\* Precio solo de la estructura. Sumar el precio de la encimera elejida.

\* Estructura prevista para la encimera con faldón

## Incrementos de acabados

Cambio de Color	RAL	Cajón / Balda	80 €
-----------------	-----	---------------	------

## Accesorios y recambios

### Rejillas de evacuación



Blanco

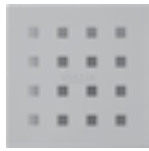

Pérgamo



Grafito



Cromo  
Brillo

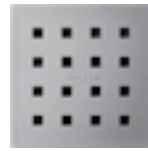

Cromo  
Mate



Tapa resina  
Piedra



Circular



Inox



Rejilla Inox 316



Tapa resina Canto



Tapa resina Caliza

### Datos técnicos válvulas

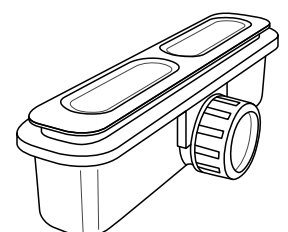
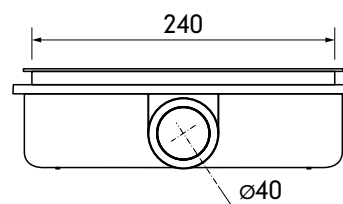
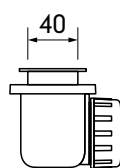
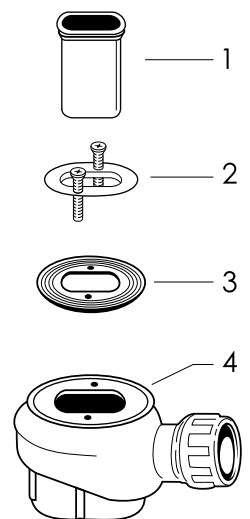
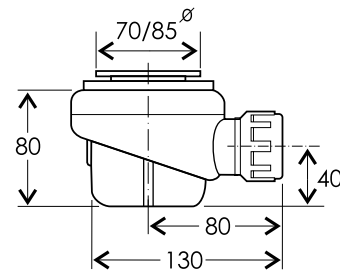
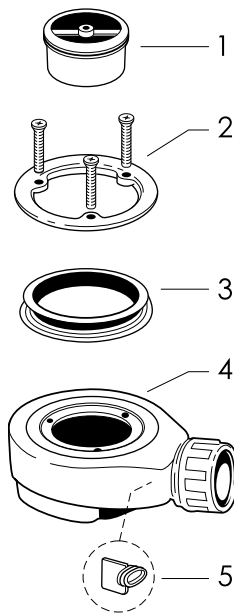
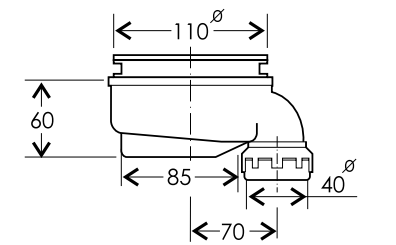
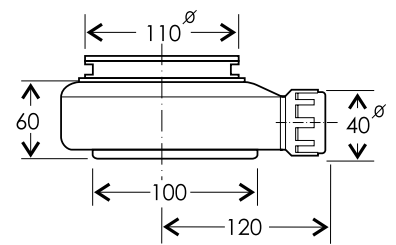

## Accesorios y recambios

Válvula Doccia ø90 horizontal 60	suplementaria	<b>24 €</b>	39 l/mn	DIN EN 274
Válvula Doccia ø90 vertical 60	suplementaria	<b>24 €</b>	33 l/mn	
Válvula con drenaje lineal	suplementaria	<b>32 €</b>	33 l/mn	
Válvula Viega ø90 horizontal 60	suplementaria	<b>32 €</b>	27 l/mn	
Válvula Viega ø90 vertical 80	suplementaria	<b>32 €</b>	33 l/mn	DIN EN 274
Válvula Viega ø50 horizontal 80	suplementaria	<b>32 €</b>	43 l/mn	DIN EN 274
Rejilla metálica desagüe 15x15	suplementaria	<b>28 €</b>		
Rejilla Resina desagüe 15x15	suplementaria	<b>28 €</b>		
Rejilla inox desagüe circular ø110	suplementaria	<b>28 €</b>		
Rejilla Inox desagüe lineal 70/80/90/100	suplementaria	<b>56 €</b>		
Rejilla resina desagüe lineal 80/90/100	suplementaria	<b>56 €</b>		
Kit de reparación impacto	suplementaria	<b>24 €</b>		
Kit de renovación plato completo	suplementaria	<b>48 €</b>		
Piezas Sueltas de Válvula (ej. Tapón).	suplementaria	<b>18 €</b>		
Portes*	suplementaria	<b>18 €</b>	< 10 kg	

\* Los precios de los accesorios no incluyen portes.

\* España continental

## Embalaje

Nuestros platos de ducha serán entregados en una caja de madera paletizada.

Esta caja está fabricada a medida y está perfectamente ajustada a las dimensiones del plato, para una mejor protección durante el transporte.

El plato de ducha está protegido por poliestireno en todas sus caras.

Con cada plato de ducha, se entrega la válvula de desagüe, la rejilla y las instrucciones de montaje.



## Contiene

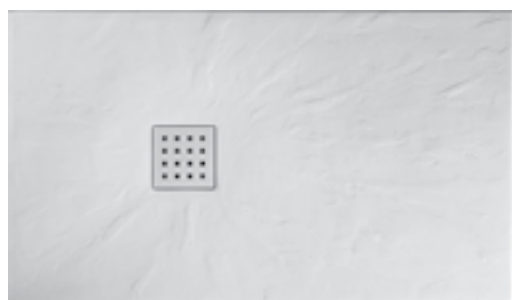

## Almacenaje y verificación

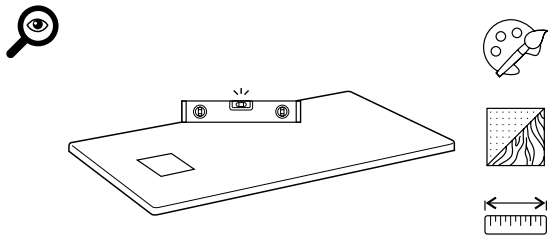
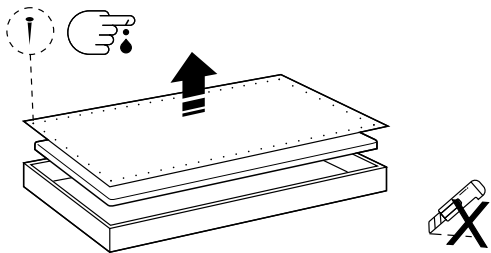
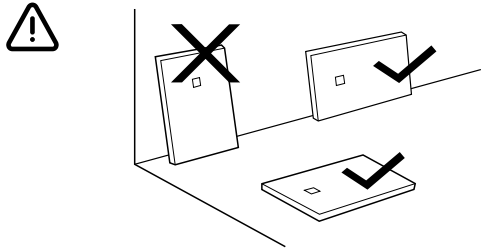

Almacenar el plato de manera correcta.

Al abrir el embalaje, se debe tener cuidado de no arañar o dañar el plato de ducha.

Antes de instalar el plato de ducha, comprobar que:

- Desagua correctamente
- No existen anomalías o daños superficiales.
- Modelo, medida, color y textura son correctos.

No se aceptan reclamaciones sobre el producto una vez instalado.



## Consejos de Montaje

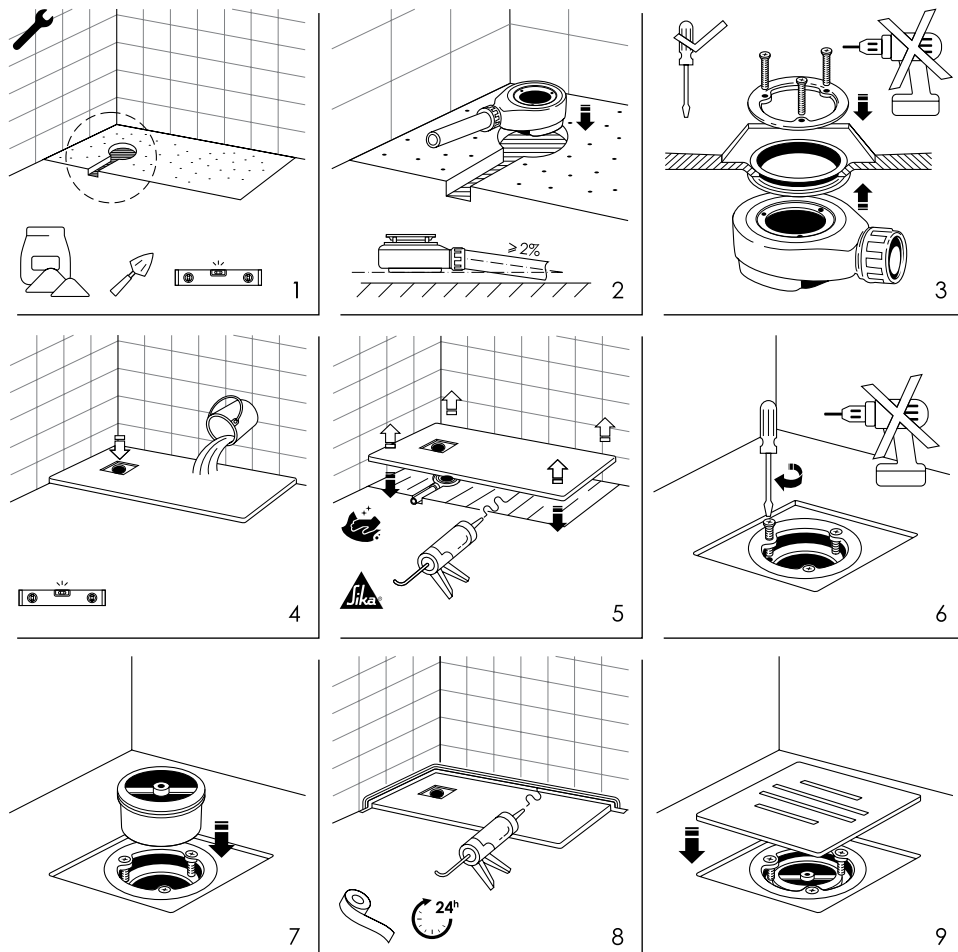
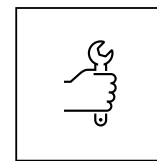

## INSTALACIÓN DEL PLATO DE DUCHA:

Recomendación Inicial: Si el plato de ducha a instalar mide más de 160 cm. se recomienda elevar varios milímetros la parte trasera para aumentar la pendiente de desagüe.

1. Preparar la base de apoyo para el plato de ducha con el hueco para la válvula de desagüe. Alisar y nivelar.
2. Colocar la válvula en la base conectándola al desagüe mediante un tubo de PVC. Comprobar que no sobresale por encima de la base. La pendiente del tubo debe ser al menos del 2%.
3. Insertar la junta de goma bordeando el interior del desagüe del plato de ducha. Colocar el plato sobre la base de apoyo haciéndolo coincidir con el centro de la válvula. Montar la anilla de sujeción apretando los tornillos uniformemente. No utilizar atornillador eléctrico.
4. Comprobar que el plato desagua correctamente y está nivelado.
5. Desmontar la válvula de desagüe. Retirar el plato de ducha y limpiar la base de apoyo. Aplicar el adhesivo recomendado ( Sikaflex o similares ) y fijar el plato de ducha a la base comprobando que esté nivelado.
6. Volver a montar la válvula de desagüe. No utilizar atornillador eléctrico.
7. Insertar el tubo de inmersión en la válvula.
8. Proteger la superficie del plato con cinta de enmascarar. Proceder al sellado de las juntas mediante silicona, masilla o similares. Esperar un mínimo de 24h para asegurar su correcto secado.
9. Colocar la rejilla embellecedora. El plato de ducha está listo para su uso.

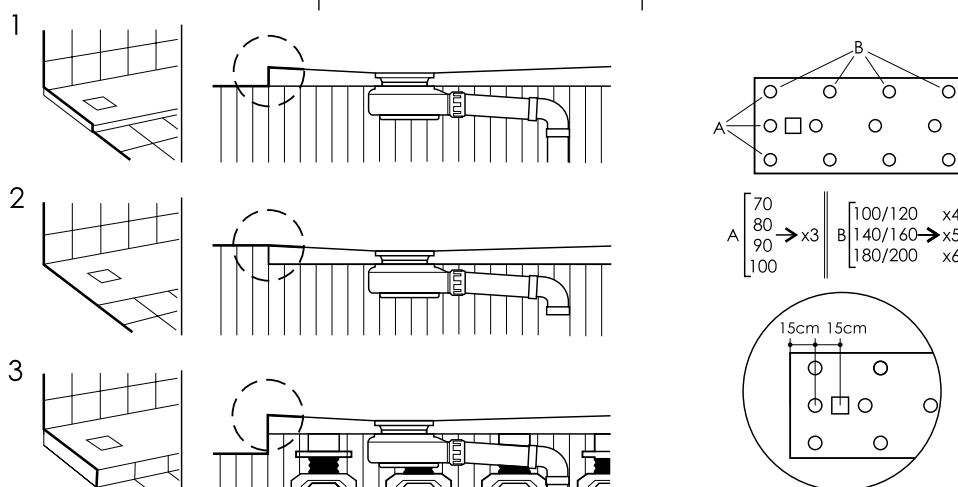

## OPCIONES DE INSTALACIÓN

1. Básica / 2. Encastrada / 3. Elevada

Esquema de colocación de los soportes de elevación regulable.

(Soporte recomendado: Antideslizamiento y con tuerca de ajuste 88-172mm)



## Manual de Instalación Paneles de baño

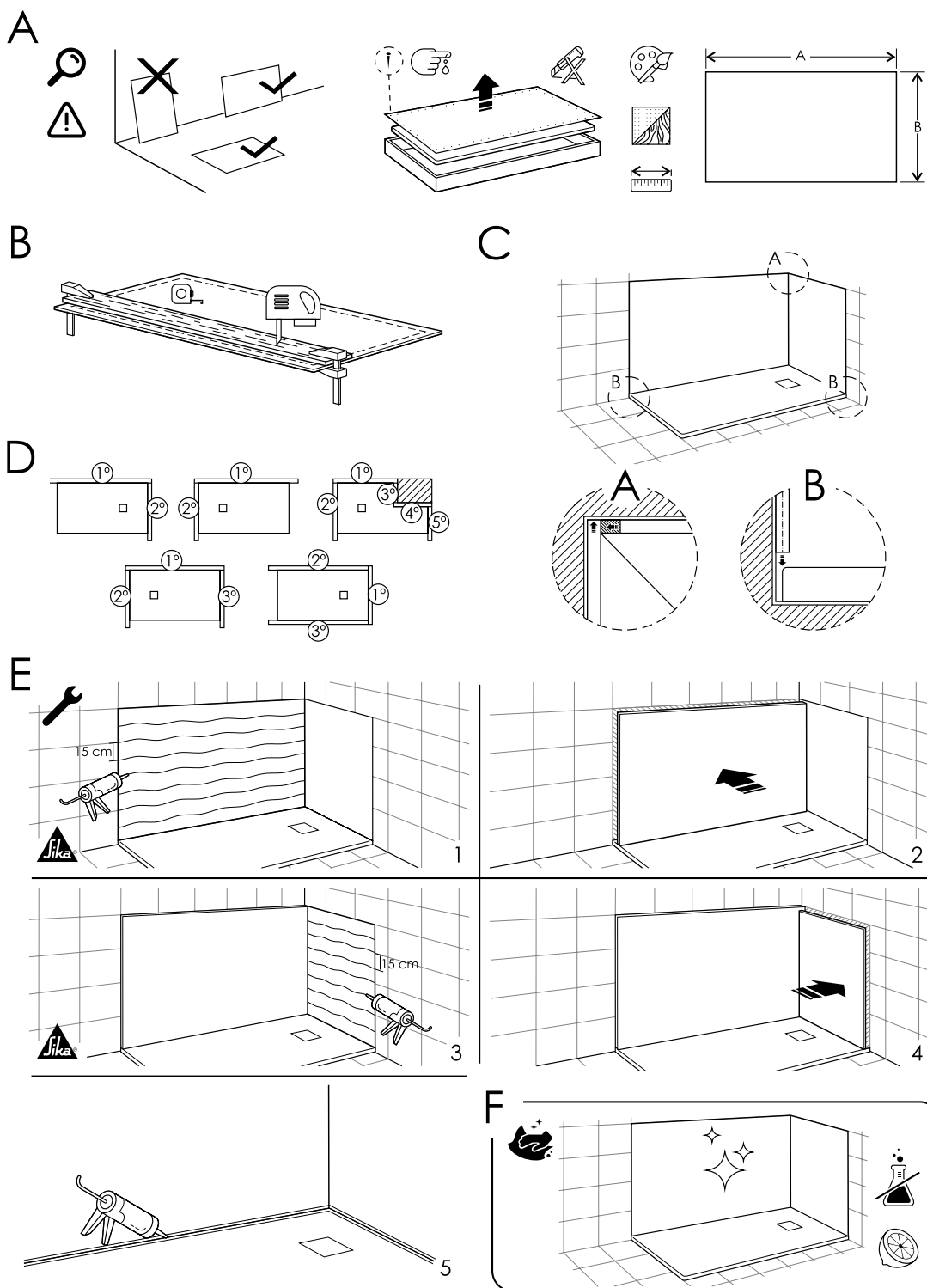

A

**IMPORTANTE:**

Antes de instalar el panel de baño, por favor, comprobar:

- Que modelo, medida, color y textura son correctos
- Que no existen anomalías o daños superficiales

No se aceptan reclamaciones sobre el producto una vez instalado.

B

**CORTE DEL PANEL DE BAÑO**

C

**VERIFICACIÓN:**

Presentar los paneles en su posición final antes de su instalación. (A) Los paneles deben superponerse.

(B) Deben colocarse sobre el plato de ducha.

D

**CONFIGURACIÓN:**

Orden de montaje según la configuración de la estancia.

E

**INSTALACIÓN**

F

**LIMPIEZA Y MANTENIMIENTO:**

Utilizar un paño suave o esponja húmeda no abrasiva con jabón neutro y agua tibia. Aclarar y secar. No utilizar productos de limpieza o desinfectantes agresivos.

## Manual de Instalación de encimeras de baño

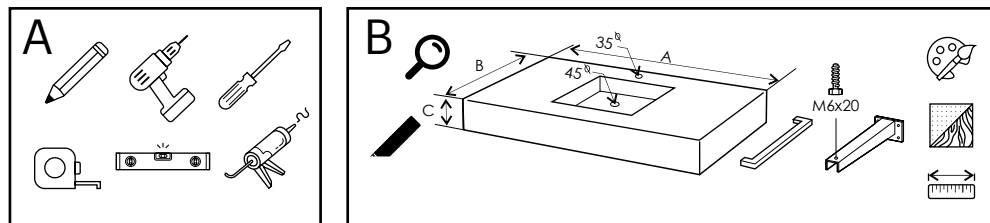
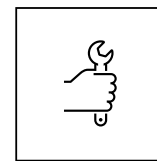

## INSTALACIÓN DE ENCIMERA DE BAÑO:

## A. HERRAMIENTAS.

## B. IMPORTANTE:

Antes de instalar la encimera, por favor, comprobar que: Modelo, medida, color y textura son correctos / No existen anomalías o daños superficiales. No se aceptan reclamaciones sobre el producto una vez instalado.

## C. INSTALACIÓN DE LA ENCIMERA.

## D. LIMPIEZA Y MANTENIMIENTO DE LA ENCIMERA:

La limpieza de la encimera debe realizarse con cuidado de no dañar la superficie. Utilizar un paño suave o esponja húmeda no abrasiva con jabón neutro y agua tibia.

Para las encimera blanco mate y solo en caso de que se requiera una limpieza más profunda, es posible utilizar una lija superfina (P800) sobre la mancha.

No utilizar productos de limpieza o desinfectantes agresivos.

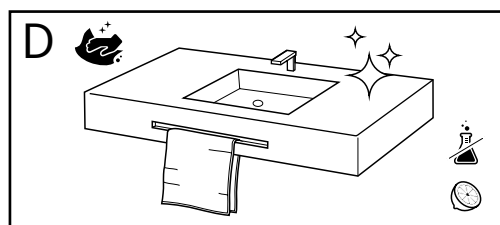
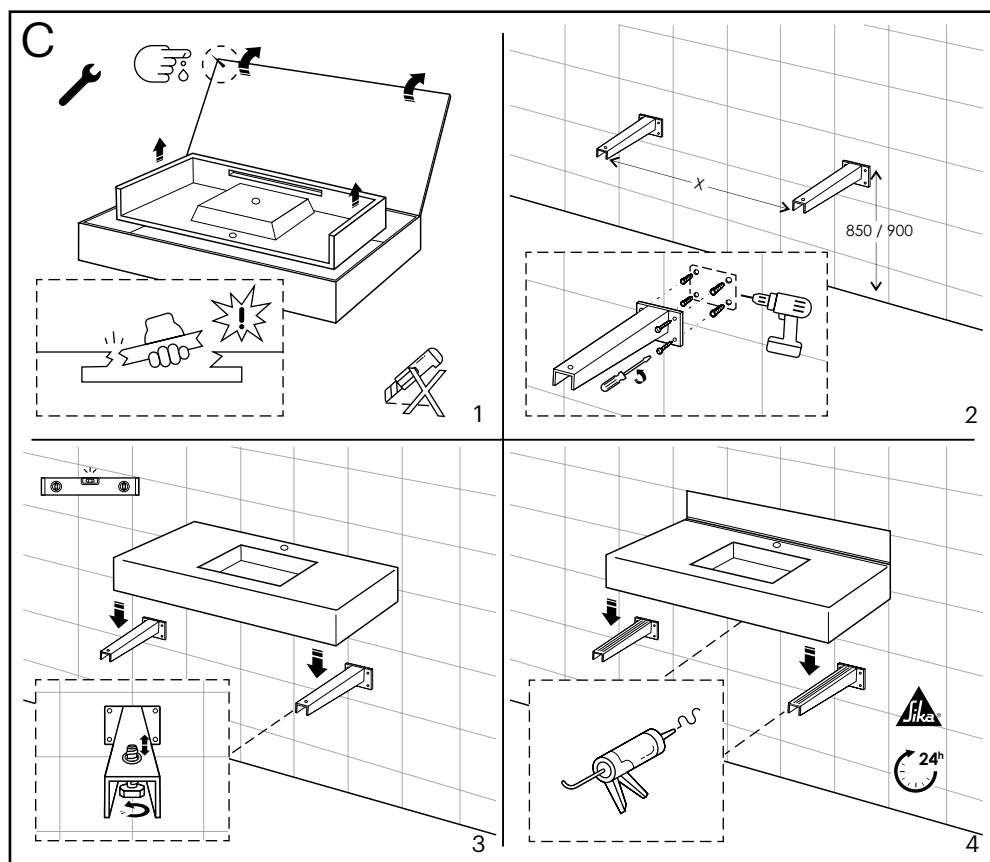

## Consejos de limpieza y de mantenimiento



### MANTENIMIENTO DIARIO

Para la limpieza y el mantenimiento cotidiano, está recomendado utilizar una esponja, no abrasiva, con agua caliente y jabón. Es aconsejable usar detergentes neutros, no agresivos y no corrosivos.

### MANTENIMIENTO Y LIMPIEZA DE LA SUCIEDAD EN CONDICIONES NORMALES

Para eliminar las manchas las más comunes, se aconseja el uso de detergentes multiusos, del tipo limpiadores que contengan lejía, un cepillo o una esponja no abrasiva. Frotar sobre toda la superficie con movimientos circulares

### MANTENIMIENTO Y LIMPIEZA DE LAS MANCHAS PERSISTENTES

Para una limpieza en profundidad y para eliminar las manchas persistentes tal como quemaduras superficiales, tintes de cabello, tintas,... Se aconseja aplicar un detergente ligeramente abrasivo o un limpiador con lejía sobre la superficie, frotando con una esponja medianamente abrasiva (preferentemente usada). Aclarar con agua antes de secar.

Si las manchas son muy persistentes, aconsejamos usar un disolvente universal para los platos con colores claros. Y para los colores oscuros, limpiar con un trapo y vinagre blanco o vinagre de alcohol diluido al 50% con agua.

Dejar actuar durante varias horas y aclarar con agua.

### PRECAUCION EN EL USO DE PRODUCTOS DE LIMPIEZA

La vida del producto depende mucho de las condiciones de mantenimiento. Cualquier superficie o material puede ser definitivamente dañado por la exposición a productos químicos o solventes potentes. Algunos productos atacan directamente la estructura y los compuestos del producto.

Los productos DOCCIA son muy resistentes a la abrasión, sin embargo, se desaconseja utilizar objetos cortantes y puntiagudos, productos demasiados abrasivos que puedan dañar la superficie y causar rasguños.

El uso de los productos químicos no es necesario en un mantenimiento regular.

Aconsejamos:

- Evitar el uso de productos con un PH elevado. Los productos corrosivos como limpiadores para hornos. Con ácidos no alimentarios (agua fuerte, amoníaco), detergentes, productos con prefijo "tri" o "tetra", tintes para cabello.
- Productos que contienen Diclorometano como decapante de pinturas y barnices, desengrasantes industriales o domésticos, ácidos Clorhídrico (formula HCl) o cloruro de Hidrogeno presentes en algunos productos de limpieza de metales, tratamiento del cuero, desatascadores, renovadores de mármoles, cerámicas y cobres oxidados.
- Los estropajos abrasivos o metálicos. Los limpiadores en polvo. Los productos con trementina o alcohol.
- La aptitud a la limpieza y la resistencia a productos químicos están certificadas por la norma UNE-EN 14527:2006 Apdo. 5.2.1 y 2.

Las pruebas realizadas por un laboratorio independiente han dado un resultado satisfactorio, sin alteración de la textura, ni del brillo, ni del color de los platos de ducha. Las pruebas se han efectuados con productos químicos como: Ácido Acético 10% v/v Hidróxido sódico 5% m/m Etanol 70% v/v Hipoclorito sódico Azul de metileno 1% m/m.

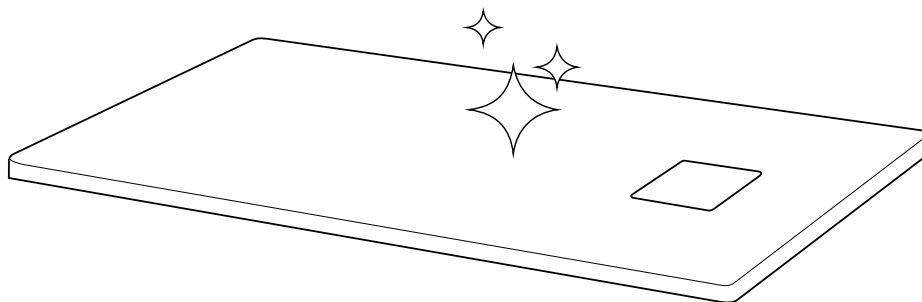

## Consejos de reparación

En algunos casos existe la posibilidad de recuperar el aspecto original del plato de ducha cuando este ha sufrido daños reversibles, tales como arañazos profundos y superficiales, o pequeñas lascas desprendidas a consecuencia de un choque sobre la superficie de Gel Coat.



### REPARACIONES SUPERFICIALES

Cualquier arañazo o rayón superficial puede ser reparado procediendo de la siguiente manera:

- Lijar la parte de la superficie dañada y alrededores con un papel lija de vidrio de grano 100.
- Afinar el lijado aplicando primero una pasada con una lija de vidrio de grano 200 y después de grano 400.
- Para acabar, humedezca ligeramente la superficie lijada pasando finalmente una lija de vidrio de grano 600.

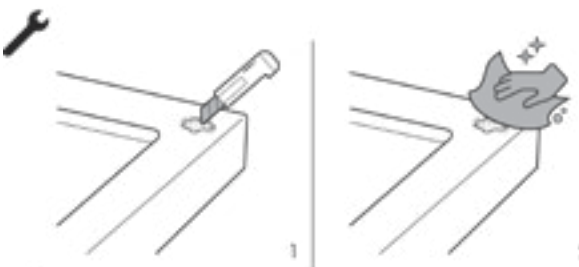

Según el tipo de textura y el tamaño del rasguño a tratar, esta reparación puede dejar una diferencia de brillo, de tacto o de tono.



### REPARACIONES DE DAÑOS IMPORTANTES Y RENOVACION DE LA CAPA DE GEL COAT

Para casos en los que el GEL COAT haya sufrido daños importantes consecuencia por ejemplo, de golpes con la alcachofa de ducha o con herramientas. O si el revestimiento hubiese sufrido una degradación en su conjunto a causa del uso de productos corrosivos.

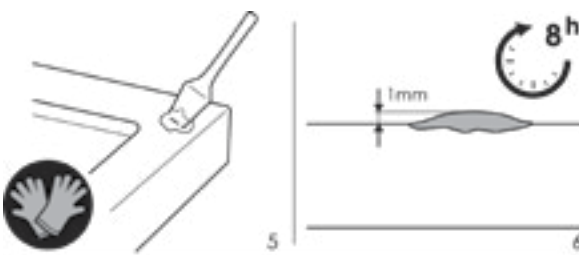

Es posible intentar una renovación completa de la superficie del plato de ducha con la ayuda de un Kit de Reparación.

Este kit lo constituye el Gel Coat, en el color que se precise, un catalizador, que permitirán una vez hecha la mezcla reconstituir el revestimiento del producto.

Una vez se tenga la superficie seca, el acabado de debe hacer con ayuda de un papel de lija de vidrio siguiendo los pasos indicado en el epígrafe "Reparaciones superficiales".

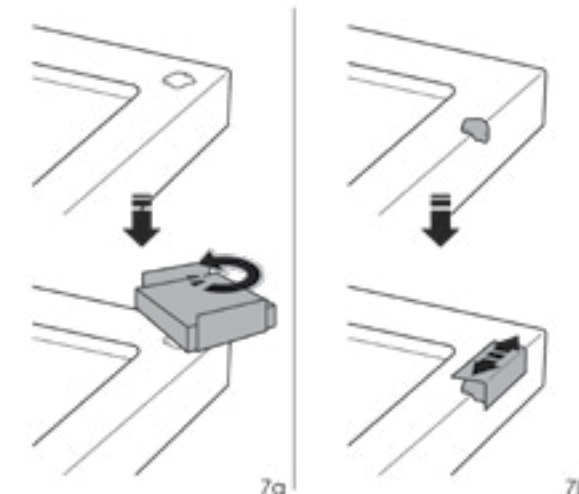

## Aptitud a la limpieza y resistencia a las manchas y agentes químicos (Norma EN 14527 2006 anexo 5.2)

PRODUCTOS UTILIZADOS PARA LA PRUEBA		EXPOSICIÓN	RESULTADO VALORACIÓN LIMPIEZA CON AGUA	LIMPIEZA CON AGUA Y AGENTES ABRASIVOS
Ácido acético 10% v/v:	Vinagre, solvente	48h	Sin deterioro de la superficie	-
Hidróxido sódico 5% m/m:	Sosa cáustica, desatascador de tuberías, cosméticos.	24h	Ligero cambio de brillo	Alteración eliminada
Etanol 70% v/v:	Solventes, carburante, alcohol.	48h	Ligero cambio de brillo	Alteración eliminada
Hipoclorito sódico:	Lejía, desinfectantes, agente blanqueador.	48h	Sin deterioro de la superficie	-
Ácido Clorídrico:	Decapantes industriales, antical.	48h	Alteración del brillo	Alteración eliminada
Ácido Sulfámico:	Limpiadores antical (Cillit Bang).	48h	Alteración del brillo	Alteración eliminada
Nitrógeno líquido:	Insecticidas	48h	Sin deterioro de la superficie	-
Amoniaco:	Tinte para cabello, desengrasantes, limpiadores..	48h	Ligero cambio de brillo	Alteración eliminada
Ácido Nítrico:	Agua fuerte, decapante industrial.	48h	Ligero cambio de brillo	Alteración eliminada
Azul de metileno 1% m/m:	Extremadamente colorante.	24h	Superficie manchada	Mancha eliminada
Ácido sulfúrico 70% v/v:	Colorantes, detergentes, decapantes de metales.	48h	Ligero cambio de brillo	Alteración eliminada
Acetona:	Pinta uñas, pegamentos, solventes.	48h	Ligero cambio de brillo	Alteración eliminada
Esencia de trementina:	Quitamanchas, betún, barniz, solventes.	48h	Sin deterioro de la superficie	-
Povidona yodada:	Betadine®	48h	Superficie manchada	Mancha eliminada



13  
PLATO DE DUCHA DE RESINA  
DdP nº: 01  
UNE-EN 14527 – CL1  
USO DOMÉSTICO, PARA LA HIGIENE PERSONAL

## Propiedades de producto

Antideslizante Clase 3 / PN 24	Norma UNE ENV 12633: 2003 Anexo A C4 DIN 51907 PN24 (XPP05-010)
Antibacteriano	Sin proliferación
Resistencia a rasguños	Alta
Resistencia a la abrasión	Alta
Resistencia al impacto	Alta
Resistencia a la diferencia de tº	Norma EN 14527: 2006+A1: 2010 Anexo 5.3.4 HDT > 110º
Estabilidad de los colores	Alta EN 14527: 2006+A1: 2010 Anexo 5.3.2
Coloración de la masa y del Gel Coat del mismo color	En todas las texturas. También los colores RAL
Material hidrófugo	Absorción de la humedad < 0,01%
Instrucciones de montaje	Disponibles
Montaje	Pegamento-Masilla de poliuretano mono componente (SICAFLEX) Pegamento-Masilla MS polímero.
Instalación	Ras del suelo, semi-encastrada, encastrada, pies regulables.
Pies regulables	1 cada 20/30 cm
Reparación superficial	Lijado con papel de lijar: 100/220/400/600
Reparación importante	Kit de reparación y renovación disponible
Cortar	Disco diamante segmento continuo (especial cerámica)
Taladrar	Brocas para hormigón.
Instalacion de mamparas de ducha	Posible en todos los modelos
Pendiente	1% de media
Orificio de desagüe (EN251)	EN 14527: 2006+A1: 2010 Anexo 5.2.2
CE	Certificado DdP Nº: 01. Clase 1. 9/7/2013
ISO 9001: 2008	Certificado nº 048771-1 Exp: 28/08/2016
Embalaje	Caja de madera paletizada
Densidad de la masa	Aprox. 1940 kg / m³

## Nuestro compromiso con la calidad y la seguridad

Todos nuestros productos han sido realizados para cumplir con la mayor exigencia respecto a las normas europeas más actuales en materia de calidad y seguridad.

En las diferentes etapas de control de las materias primas y de la elaboración de nuestros productos, garantizamos el nivel más alto de calidad exigido por el mercado internacional.

**BUREAU VERITAS**  
Certification

**BUREAU VERITAS**  
1828

**Certificación**  
Certification

Concedida a / Awarded to

**MAMPARAS DOCCIA SL**

SEDE CENTRAL : POL.IND. SAN NICOLAS 1, PARCELA 34, 41500, ALCALÁ DE GUADAIRA, SEVILLA.  
VER ANEXO / See Annex

**Bureau Veritas Certification certifica que el Sistema de Gestión ha sido auditado y encontrado conforme con los requisitos de la norma:**  
Bureau Veritas Certification certify that the Management System has been audited and found to be in accordance with the requirements of standard:

**NORMA / STANDARD**

---

**ISO 9001:2008**

**El Sistema de Gestión se aplica a:**  
Scope of certification

---

VER ANEXO / See Annex

**Número del certificado:** ES071961-1  
Certificate Number

**Directors de Certificación / Certification Manager**

**Aprobación original :** 21/03/2016  
Original approval date :

**Certificado en vigor:** 21/03/2016  
Effective date:

**Caducidad del certificado:** 14/09/2018  
Certificate expiration date:

*(Signature)*

La presente Organización ha estado certificada conforme a la norma indicada bajo acreditación desde 23/09/2001 hasta 20/03/2016.  
This organization has been certified according to the specified standard under accreditation from 23/09/2001 to 20/03/2016.

Este certificado está sujeto a los términos y condiciones generales y particulares de los servicios de certificación  
This certificate is valid, subject to the general and specific terms and conditions of certification services

Entidad de Certificación / Certification Body: Bureau Veritas Iberia S.L.  
C/Valerillo Primera 22-24, Edificio Caixa, Pol. Ind. La Grana, 28108 Alcobendas - Madrid, Spain

1/2

**ENAC**  
CERTIFICACIÓN  
N° 04/C-SC004



## Condiciones generales de venta DOCCIA GROUP

Salvo acuerdo contrario por escrito, todas las ventas están sujetas a las condiciones generales de venta que aquí se indican. Las condiciones generales de compra del comprador no están reconocidas por DOCCIA GROUP S.L. Las declaraciones que puedan hacer nuestros representantes no son reconocidas por la empresa

excepto confirmación expresa por parte de DOCCIA GROUP S.L. Las descripciones y fotografías contenidas en el catálogo deben ser consideradas únicamente a título de información. La empresa se reserva el derecho de modificar total o parcialmente los productos, en cualquier momento y sin necesidad de notificación.

### PEDIDO:

Los pedidos deben ser hechos siempre por escrito, por email (pedidos@mamparasdoccia.es) o por fax (902 197 196), con el fin de evitar todo error o malentendido posible. El hecho de enviar un pedido o de recibir una mercancía, lleva intrínseco la aceptación irrevocable de las condiciones generales de venta, adquiriendo un carácter contractual únicamente tras la confirmación escrita del pedido por parte de DOCCIA GROUP S.L..

### ANULACION DE PEDIDOS DE PRODUCTOS ESTANDAR:

La empresa facturará gastos de anulación del 100% del valor del pedido anulado.

### ANULACION DE PEDIDOS A MEDIDA:

La empresa facturará gastos de anulación del 100% del valor del pedido a medida.

### PRECIO:

Los precios de venta serán aquellos indicados en la tarifa vigente en el momento de la recepción del pedido. La empresa se reserva el derecho de modificar los precios sin preaviso. Los precios de la tarifa se entienden cómo PRECIO PUBLICO RECOMENDADO SIN IVA.

### IMPUESTOS:

Los impuestos, cualquiera sea su naturaleza, no están reflejados en la tarifa de precios. Serán incluidos en la factura conforme a la legislación en vigor.

### PLAZO DE ENTREGA:

DOCCIA GROUP S.L. entregará la mercancía en la dirección del cliente o a la dirección de entrega especificada por el mismo en el momento del pedido. Los plazos de entrega son meramente indicativos, y no serán en ningún caso, motivo de modificación o anulación del pedido. Los plazos de entrega no serán nunca argumento para la realización de ninguna reclamación. Si alguna condición de venta no pudiese ser respetada por causas ajenas a nuestra voluntad, DOCCIA GROUP S.L. se reserva el derecho de modificar dichas condiciones. Comunicándolas en el menor plazo de tiempo posible, sin que esto en ningún caso pueda significar el no cumplimiento del contrato o una indemnización, cualquiera sea su naturaleza.

### DAÑOS PRODUCIDOS DURANTE EL TRANSPORTE:

En el caso de que la mercancía o el embalaje sufrieran daños a consecuencia del transporte, el cliente debe comunicar dichos daños, de forma debidamente documentada, en un plazo máximo de 48 horas a contar desde el momento de la recepción de la mercancía.

En caso de reclamación justificada y comunicada en el plazo estipulado, DOCCIA GROUP S.L. procederá al envío de reposición. Si el comprador no comunicara la reclamación en el plazo de 48h. la empresa se reserva el derecho de no responder a dicha reclamación y el comprador se verá privado de los derechos que le pudieran asistir.

### DEVOLUCION DE MERCANCIA:

La empresa no acepta ninguna devolución sin previa aceptación expresa. Únicamente el departamento de atención al cliente está autorizado a dar una respuesta favorable a la devolución de mercancía y dar la orden de recogida. En caso de devolución de una mercancía no autorizada, la empresa se reserva el derecho de facturar al cliente los gastos derivados de esta devolución.



**GARANTÍA:**

La mercancía está garantizada según la norma europea en vigor.

La garantía no cubre los deterioros no imputables al producto o deterioros derivados de un uso negligente. La garantía no cubre deterioros derivados de una mala manipulación o de un uso inapropiado.

Excluido de la garantía:

Los defectos y deterioros provocados por el desgaste natural de piezas, los fenómenos meteorológicos, los daños causados por la dureza del agua o los daños que pudieran derivarse de un mantenimiento negligente o defectuoso.

Los daños en la superficie del producto resultado de impactos, choques o golpes no están cubiertos por la garantía. La garantía dejará de tener validez para todo producto cuya instalación, ejecución de obra o mantenimiento no hayan sido efectuados según nuestras reglas de manipulación y montaje.

Los deterioros consecuencias del corte, la perforación y cualquier otra transformación del plato de ducha suministrado no estarán cubiertos por la garantía.

En caso de defecto reconocido por la empresa, nuestra garantía está estrictamente limitada a la reposición del producto defectuoso, excluyendo cualquier gasto e indemnización sea cual sea su naturaleza. Dicha reposición será de un producto idéntico, dentro de los límites de fabricación y de la disponibilidad de stock. En caso contrario el compromiso de garantía se verá satisfecho por la reposición de un producto equivalente. No podemos en ningún caso ser tomados como responsables de un daño, cualquiera que sea su naturaleza, resultado del contacto del material producido por DOCCIA GROUP S.L. con cualquiera de los productos señalados en el apartado “recomendaciones de limpieza y mantenimiento”.

**JURISDICCIÓN:**

Para toda cuestión relativa a las relaciones comerciales y jurídicas, los implicados acuerdan y reconocen cómo única jurisdicción competente, la establecida en la ciudad de Sevilla en España, lugar dónde DOCCIA GROUP S.L. tiene establecido su domicilio social.

**COPYRIGHT:**

Todas las imágenes e ilustraciones están consideradas propiedad intelectual y están protegidas por copyright, y su reproducción total o parcial queda totalmente prohibida.

**COLORES:**

La mercancía entregada no debe necesariamente corresponder a la muestra suministrada, que define de manera no contractual el aspecto general del producto. Pueden darse diferencias en el tono del tinte o en el aspecto entre la imagen en las fotografías y en producto entregado. Esta diferencia no puede ser nunca motivo de reclamación.

**CORTES:**

Los cortes encargados a DOCCIA GROUP S.L. serán realizados tomando como base, información escrita tal como un plano acotado. Los cortes serán como mínimo de centímetro en centímetro con una tolerancia de variación de 10%. Doccia se compromete a reconstituir los cantos cuando esto sea necesario en cuanto a la apariencia del producto, y en cuanto a la demanda del cliente. Los lados con corte que tras la instalación no sean visibles, no tendrán el acabado del resto de la superficie del plato.

**DISTANCIA DEL DESAGÜE:**

La posición de la válvula de desagüe varía según las dimensiones de cada plato de ducha. La posición aproximada de la válvula de desagüe está indicada en el esquema técnico, sin embargo, debido al carácter artesano de la fabricación, esta distancia puede variar entre 1 y 3 cm. según al molde utilizado en dicha fabricación.

**DIMENSION DE LOS PLATOS DE DUCHA:**

La masa utilizada en la fabricación de los platos de ducha DOCCIA se vierte en moldes rígidos, lo que da como resultado un producto de medidas regulares. Aún así, tratándose de un material que contrae durante el proceso de secado, la altura y el espesor podrían experimentar una variación de algunos milímetros.



P.I. San Nicolás Uno, Parcela 34.  
41500 Alcalá de Guadaíra.  
Sevilla (Spain)

T. (+34) 902 120 038

F. (+34) 902 197 196

[www.docciagroup.com](http://www.docciagroup.com)

#### FRANCE

T. 01 76 54 52 11

F. +34 955 630 796

[atcfrance@docciagroup.com](mailto:atcfrance@docciagroup.com)

[atcfrance2@docciagroup.com](mailto:atcfrance2@docciagroup.com)

#### ITALIA

T: (+39) 081.712.2904 (Italy)

T. 0034 954 038 390 (Spain)

[customerservice@docciagroup.com](mailto:customerservice@docciagroup.com)

#### UK Customer Services Office

T: 02034 994512

02034 994512

[customerservice@docciagroup.com](mailto:customerservice@docciagroup.com)

#### DEUTSCHLAND

T. +34 954 038 390

T. +34 902 120 038

F. +34 902 197 196

[germany@docciagroup.com](mailto:germany@docciagroup.com)

[customerservice@docciagroup.com](mailto:customerservice@docciagroup.com)



**ES-V211**